

PFS UPDATE DELIVERS OUTSTANDING RESULTS

75% INCREASE IN CINOVEC NPV TO US\$1.94B

16% INCREASE IN PRODUCTION TO 29,386TPA

HIGHLIGHTS¹

- The 2019 PFS Update for the Cinovec Project has been updated to demonstrate the effect of changes in the mining process to incorporate the use of paste backfill, which results in an increase in annual production, together with changes in lithium and by-product prices to reflect current and expected market conditions.
- Annual production of battery grade lithium hydroxide monohydrate modelled to increase from 25,267 tpa to 29,386 tpa, an increase of 16%.
- NPV₈ (post tax) increases from US\$1.108B to US\$1.938B, an increase of 74.9%, based upon a lithium hydroxide price of USD17,000 per tonne which is significantly less than the current price.
- Post tax IRR of 36.3% and a payback period of 2.5 years from the commencement of production.
- Up-front capital cost due to backfilling plant and additional capital costs to produce 29,386 tpa lithium hydroxide increased to US\$644m.
- This 2022 PFS Update assumes the life of mine extraction of 13.1% of the Measured and Indicated JORC Resources at Cinovec.
- Use of tailings for backfill will result in a far smaller environmental impact, further enhancing the Project's already strong ESG credentials.

European Metals Holdings Limited (**EMH or the Company**) (**ASX & AIM: EMH, OTC – Nasdaq Intl ADS: EMHXY**) is pleased to announce the results of the mining update to the 2019 Pre-Feasibility Study (**2022 PFS Update**), led by mining definitive feasibility study (**DFS**) consultant Bara Consulting, on the backfilling potential of the Cinovec mine, in which it has a 49% economic interest, in the Czech Republic.

The study updates the outcomes of the previously updated pre-feasibility study announced on 17 June 2019 (**2019 PFS Update**), for changes in the mining process as well as an increase in annual production and changes in lithium and by-product prices.

As a result of the conclusions of the study, Geomet s.r.o. (**Geomet**) has changed the planned mining method for the Cinovec orebody from open stoping to longhole stoping with backfill using paste backfill. This change, together with other changes to the material assumptions outlined in this update, increases the Cinovec mine's proposed ore extraction from 34.5mt up to 54.5mt, enabling an increase in the annual processing rate by approximately 33% per annum over the previous 21-year life of mine, from 1.69mtpa to 2.25mtpa over a now 25-year life of mine.

¹ Dollar figures throughout the announcement are in US Dollars; increases refer to results in this announcement compared to 2019 PFS Update

DIRECTORS AND MANAGEMENT

Keith Coughlan
EXECUTIVE CHAIRMAN

Richard Pavlik
EXECUTIVE DIRECTOR

Kiran Morzaria
NON-EXECUTIVE DIRECTOR

Lincoln Bloomfield
NON-EXECUTIVE DIRECTOR

Dennis Wilkins
COMPANY SECRETARY

CORPORATE INFORMATION

ASX EMH

AIM EMH

NASDAQ ADS EMHXY

Frankfurt E861.F

CDI'S ON ISSUE 175.4M

Keith Coughlan, Executive Chairman, said "I am very pleased to report to shareholders on the completion of this 2022 PFS Update for the Cinovec Project which adds significantly to the already robust forecast economics for the project. The results of the study are very positive for the overall economics, resulting in a far greater amount of the ore resource being utilised for production of lithium and increasing the after tax NPV₈ from USD1.1B to USD1.94B. The increased NPV assumes a long-term price for lithium hydroxide of US\$17,000 per tonne. An increase in the lithium hydroxide price by 30% to USD 22,100 would increase the NPV₈ (post tax) to over USD 3B (refer to figure 13 on page 25). Given the current price of lithium hydroxide is in the vicinity of USD 40,000 per tonne it is clear that that the Cinovec Project will be critical to European battery self-sufficiency.

"The use of approximately 54% of the plant tailings for backfill will result in a far smaller environmental impact, with much smaller dry stack tailings storage required, further enhancing the already strong ESG credentials of the Project.

"The significant increase in lithium produced will further add to the supply security of the European battery industry. Importantly, even at this increased production rate, the resource is nowhere near fully utilised – paving the way for future assessment of further production increases.

"Cinovec is strategically located in central Europe, in close proximity to the continent's vehicle manufacturers. With increasing demand for electric vehicles and the expected demands of grid storage capacity, the project is very well placed to supply the European lithium market for many decades"

The Cinovec Project remains a potential low operating cost lithium hydroxide producer, due to a number of key advantages:

- By-product credits from the recovery of tin, tungsten and potash;
- Paramagnetic properties of zinnwaldite allow the use of low-cost wet magnetic processing to produce a lithium concentrate for further processing at relatively high recoveries;
- Relatively low temperature roasting at atmospheric pressure utilizing conventional technologies, reagent recycling and the use of waste gypsum from power stations;
- Low-cost access to extensive existing infrastructure and cost-effective grid power;
- Global warming potential (GWP) impact mitigation planning recently identified solar power, battery-electric mining fleet, Hypex Bio explosives and the potential use of green hydrogen for thermal energy which could make Cinovec's lithium chemicals have some of the lowest CO₂ intensity in the world if all impact mitigation strategies are pursued.
- Highly skilled workforce and comparatively low costs of employment;
- Historic mining and chemical plant region – strong support by the local community for job creation in areas that have both historic and current mining and chemicals operations;
- The deposit lies in a stable jurisdiction, located centrally to the rapidly expanding electric vehicle industry, which is forecast to be the main driver behind increasing lithium consumption; and
- Established and transparent mining code.

CINOVEC PROJECT OVERVIEW

The Cinovec Project is located in the Krusne Hory Mountains which straddle the border between the Czech Republic and the Saxony State of Germany and comprises the Cinovec mine and nearby brownfield land upon which the lithium production facilities will be built. The project is within a historic mining region, with artisanal mining dating back to the 1300s.

In the 1940s a large underground mining operation was established primarily to produce tungsten for the war effort. Mining and processing activities continued under the Czechoslovakian Government with the mine continuing to expand and producing tin as well as tungsten. Due to the fall of communism and lower tin prices, the mine was closed in 1993. In 2011, the old processing plant was removed and the site rehabilitated.

In 2014, EMH commenced a drilling campaign to validate the comprehensive data generated by the earlier exploration activities. The Company's on-going drilling programme had completed 26 diamond holes for a total of 9,477m drilled by 2017, successfully validating earlier drilling results, adding lithium grade data and providing metallurgical test-work samples.

In 2015, EMH completed a Scoping Study for the Cinovec Project (**2015 Scoping Study**). The 2015 Scoping Study highlighted that the size, grade and location of the deposit made it a very attractive development opportunity and recommended that the project proceed through to a preliminary feasibility study.

A trade-off study was completed in November 2016 comparing the operating and capital costs of the conventional sodium-sulphate roast and the L-Max process. It was concluded that conventional roasting technology would deliver high lithium recoveries with a lower operating cost, lower technical risk, less impurity removal, and be less dependent on potassium by-product credits. The Company then selected the sodium-sulphate roasting option as the preferred method of lithium extraction for the 2017 PFS.

The 2017 Prefeasibility Study (**2017 PFS**) (refer to the Company's ASX release dated 19 April 2017) highlighted that Cinovec could be a low-cost producer of lithium carbonate via conventional roasting technology used at atmospheric pressure. The 2017 PFS estimated average production of 20,800 tpa of lithium carbonate at a cost of \$3,843/t. The PFS showed a NPV of \$540M (post tax 8%) and a capital cost of \$393M.

The updates to the pre-feasibility study announced on 17 June 2019 (**2019 PFS Update**) (refer to the Company's ASX release dated 17 June 2019) highlighted that Cinovec could be an economically robust producer of lithium hydroxide and estimated annual production of 25,267 tpa battery grade lithium hydroxide at a cost of \$3,435/tonne LiOH.H₂O. The 2019 PFS Update showed a NPV of US\$1.108B (post tax, 8%) and a capital cost of \$482.6M.

This 2022 PFS Update highlights the very strong increase in value which results from the increase in the price of battery grade lithium hydroxide when combined with the use of backfill and an increase in the overall annual production of battery grade lithium hydroxide to 29,386 tpa. This 2022 PFS Update shows an NPV of \$1.938B (post tax, 8%) and an up-front capital cost of US\$644M.

Cinovec is centrally located for European end-users and is well serviced by infrastructure, with a sealed road adjacent to the deposit, rail lines located 5 km north and 8 km south of the deposit and an active 22 kV transmission line running to the historic mine. As the deposit lies in an active mining region, it has strong community support.

CINOVEC 2022 PFS UPDATE SCOPE AND MATERIAL ASSUMPTIONS

This 2022 PFS Update was prepared by the Company based on technical reports undertaken by independent consultants who are specialists in the required areas of work. These included:

- Resource Estimation - Widenbar and Associates Pty Ltd;

- Mining - Bara Consulting Ltd (**Bara Consulting**);
- Front-End Comminution and Beneficiation (**FECAB**) - Ausenco Limited; and
- Lithium Carbonate and Hydroxide Plants (**LCP**) - Hatch Associates Pty Ltd.

During 2021, Bara Consulting completed a study into the impact that the use of backfill paste would have on the rates of extraction of the ore from the Cinovec mine.

The results of this 2022 PFS Update are based upon a mine life of 25 years processing on average 2.25 Mtpa of ore, producing 29,386 tpa of battery grade lithium hydroxide.

The sections of the previous 2019 PFS Update that have not been altered are as follows:

- Crushing, milling and slurring of the ore for transport via pipeline to the processing site;
- Processing test work;
- Tin and tungsten recovery circuits;
- The design for the roasting and leaching circuits;
- The fluoride and calcium removal circuit designs;
- Lithium hydroxide process facilities design;
- Lithium hydroxide precipitation and product handling facilities;
- Provision of utilities such as electrical power, natural gas, rail and raw water to either the mining or processing sites, other than as adjusted for the increase in production rate; and
- Ownership of the Cinovec Project and tenement regulatory regime in the Czech Republic, other than CEZ a.s. becoming a shareholder in Geomet s.r.o., the holder of 100% of the Project;
- Community support.

The Company confirms that it is not aware of any new information or data that materially affects the sections of the 2019 PFS Update that have not been altered.

The mine plan contained in this update utilises only Indicated or Measured Resources.

The sections of the 2019 PFS Update that have been reviewed or altered for this 2022 PFS Update are as follows:

- Mining method and schedule;
- Update of the pricing assumptions for lithium hydroxide, tin and tungsten;
- Update of the capital costs to increase the scale of mining operations and associated infrastructure to the higher planned production rate, as well as new estimates for a suitable backfill plant and related infrastructure;
- Update of the capital costs to increase the processing facility at the higher planned production rate; and
- Update to the operating costs to take into account backfill costs.

The increase in size of the production facility would be expected to enable economies of scale in the operating costs of production. Additionally, tailings disposal costs have been re-estimated to accommodate opportunities for disposal of additional tailings produced in the expanded mine plan.

For personal use only

Cinovec Mineral Resource Estimate

The Cinovec Project hosts a JORC (2012) code-compliant global Mineral Resource estimate of 708.2MT in the Measured, Indicated and Inferred categories as shown in Table 1 below (refer to ASX announcement dated 13 October 2021).

Table 1: Cinovec Project Mineral Resource September 2021 (0.1% Li (0.2153% Li₂O) Cut-off)

CINOVEC SEPTEMBER 2021 RESOURCE SUMMARY							
	Cut-off	Tonnes	Li	Li ₂ O	Sn	W	LCE
	%	(Millions)	%	%	%	%	MT
MEASURED	0.1 % Li (0.22% Li ₂ O)	53.3	0.22	0.48	0.08	0.02	0.64
INDICATED	0.1 % Li (0.22% Li ₂ O)	360.2	0.20	0.44	0.05	0.02	3.88
MEASURED+INDICATED	0.1 % Li (0.22% Li ₂ O)	413.4	0.21	0.44	0.05	0.02	4.51
INFERRED (approx.)	0.1 % Li (0.22% Li ₂ O)	294.7	0.18	0.39	0.05	0.02	2.87
TOTAL	0.1 % Li (0.22% Li ₂ O)	708.2	0.20	0.42	0.05	0.02	7.39

Notes:

1. Mineral Resources are not Reserves until they have demonstrated economic viability based on a feasibility study or prefeasibility study.
2. Mineral Resources are reported inclusive of any reserves and are prepared by Widenbar in accordance with the guidelines of the JORC Code (2012).
3. The effective date of the Mineral Resource is September 20, 2021.
4. All figures are rounded to reflect the relative accuracy of the estimate.
5. The operator of the project is Geomet s.r.o., 49% owned by EMH and 51% owned by CEZ a.s. Gross and Net resources attributable to EMH are also 49%.
6. Any apparent inconsistencies are due to rounding errors.
7. MT is million tonnes.
8. LCE is Lithium Carbonate Equivalent and is equivalent to Li₂CO₃.

The Mineral Resources underpinning the Cinovec Project production target have been prepared in accordance with the JORC Code 2012 by Lynn Widenbar of Widenbar and Associates, who is a competent person under the JORC Code 2012.

This 2022 PFS Update is based on mining 54.5 Mt of material, 100% of which lies within the Measured and Indicated Mineral Resource category. The tonnage used in the PFS represents only 7.7% of the total Mineral Resource and 13.1% of the Measured and Indicated Mineral resource.

Around 2.25 million tonnes of ore per annum is mined and crushed in the underground mine prior to being conveyed 1,167m to the mine portal and stacked on Comminution Plant stockpile (30 kt live capacity), providing a buffer and surge capacity between the underground activities and the processing plants.

The ore is reclaimed from the stockpile to be delivered to the start of the Front-End Comminution and Beneficiation (**FECAB**) circuit that comprises two sections of plant, geographically separated and connected by a slurry pipeline. The Comminution Plant currently features a single stage SAG mill is located near the mining portal and delivers milled ore (P80 < 212 µm) via slurry pipeline to the Beneficiation Plant, which is located adjacent to the Lithium Chemical Plant (**LCP**).

The Beneficiation Plant uses Wet High Intensity Magnetic Separation (**WHIMS**) to separate out the lithium bearing micas (zinnwaldite) and produce a magnetic mica concentrate. The ability to use wet

For personal use only

magnetic separation is unique to zinnwaldite ore because zinnwaldite contains iron in its lattice and is paramagnetic. Magnetic separation offers cost and recovery advantages over beneficiation through froth flotation.

The LCP receives the mica concentrate from the Beneficiation plant and extracts the lithium through roasting, water leaching and then purification to produce battery grade lithium carbonate. The plant also produces a potassium sulphate by-product that becomes an additional revenue source. The tailings produced by both processing plants are filtered to produce a filter cake which is dry stacked in the Tailings Storage Facility (**TSF**). Although higher cost than alternative methods, dry stacking significantly reduces environmental impact.

As confirmed by testwork conducted in both Anzaplan (Germany) and Nagrom (Perth), the quality of the lithium hydroxide produced by the LCP will meet requirements for use in lithium battery manufacturing, for which there is a growing market, strong demand and supply shortages. Current market analysis supports the battery grade lithium hydroxide price of \$17,000/tonne used in the updated economic model.

Natural gas is delivered to the project fence by pipeline, supplying low-cost energy for roasting the mica concentrate and heating the underground mining operations. Electricity requirements will be obtained from a solar power plant which will be supplemented by the existing local grid by constructing a 1,000 m overhead line to the nearby existing switchyard in Teplice (refer to ASX announcement dated 23 November 2021).

Potable and industrial water for processing make-up requirements can be purchased from the local municipality, although dewatering of the mine will supply a significant proportion of process water requirements.

MINING PLAN AND SCHEDULING

Bara Consulting, the provider of the mine design and scheduling contained in the 2019 PFS Update and the ongoing mining DFS, has completed an update of the mining plan contained in the 2019 PFS Update comparing the 2019 PFS Update "no-fill" mining plan with a paste backfill mining plan.

The paste backfill assessment has given the greatest improvement in increasing the potential percentage extraction of ore from 52.4% in the 2019 PFS Update to 77%, leaving 23% behind as structural support.

The effect of the use of the paste backfill option was to enable the mining schedule to increase the mine life to 25 years whilst increasing the amount of ore mined to 2.25mtpa thereby increasing the amount of lithium hydroxide produced each year from 25,267 tonnes per annum to 29,386 tonnes per annum.

Geotechnical Data Gathering and Rock Characterisation

A site visit was carried out by Bara Consulting in October 2016, during which a quality assurance – quality control (**QAQC**) was undertaken on borehole logging data generated by EMH. Bara Consulting also undertook geotechnical logging of core on site and selected rock samples for laboratory testing. The majority of boreholes drilled for resource estimation have now been logged for geotechnical parameters, increasing levels of confidence in the data and estimation.

The data collected was transformed into rock mass quality by using classifications such as Rock mass rating (**RMR89**), Geological Strength Index (**GSI**) and Q-index (**Q and Q**). Laboratory testing of core samples included uniaxial compressive strength with elastic moduli (**UCM**), triaxial compressive strength (**TCS**), indirect tensile strength (**UTB**) and base friction angle (direct shear) tests (**BFA**). Special ATV/Hirat logging combined with geotechnical analyses of the drill cores have been conducted in existing deep holes throughout the South and Central areas to determine rock strength and kinematic characteristics

for the crown pillar, hanging wall, foot wall and ore body pillars. A slope stability analysis on boxcut was also completed using geotechnical borehole data and ATV/Hirat logging.

Additionally, in the last quarter of 2021, geophysical electrical resistivity tomography measurements were made on 4 lines along the axis of the future mine access/egress decline tunnels. In January 2022, the results of these measurements will be confirmed by an additional two boreholes with appropriate geotechnical sampling and analysis.

Mine Design and Method

The geometry of the payable ore is largely flat or shallow-dipping and massive enough to mechanise using long-hole open stope mining methods.

The mine will be accessed by a twin decline system. A decline conveyor will be installed from the underground primary crusher, on 540masl elevation, to surface. The second decline, in parallel with and the same length as the first, will be used as a service decline for mineworkers, material and as an intake airway. A provision for a second crushing station servicing the northern zones has also been made. A schematic of the updated mine layout is shown in Figure 1.

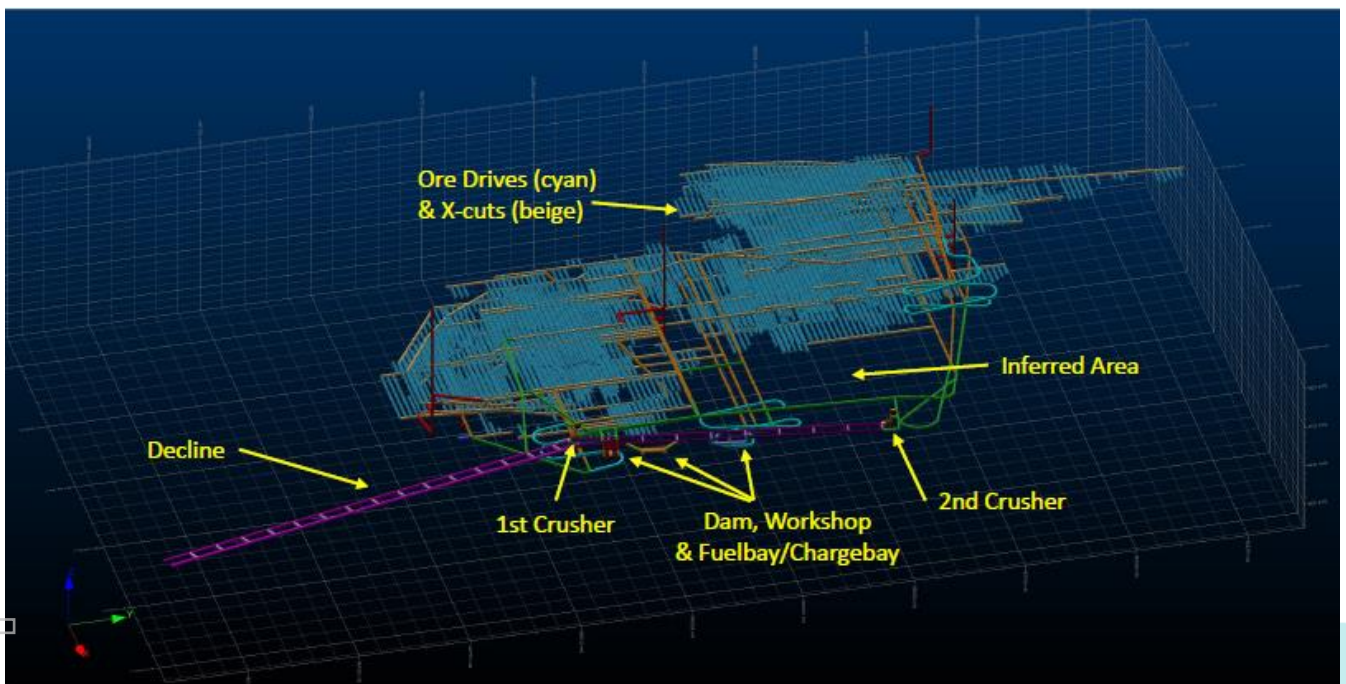

Figure 1 – 2022 PFS Update Mine Layout Infrastructure, excluding stopes

The modifying factors used to generate the production target used in this 2022 PFS Update from the Measured and Indicated Mineral resource are:

- Un-planned dilution 3%;
- Un-planned ore loss 3%; and
- Exclusion zones: any ore within 40 m vertical distance from surface was excluded from the mine plan. Ore within 5m of remnant workings was also excluded. In the northern areas where mining occurs below the village the crown pillar exclusion was increased to 150 m.

A planned "mine call factor" estimating ore losses to clay of 5% was also accounted for. To evaluate the impact of backfill at Cinovec, geotechnical aspects, stoping aspects, tailings and backfill

preparation aspects (including material handling of tailings from the FECAB and LCP locations to the backfill plant) were considered.

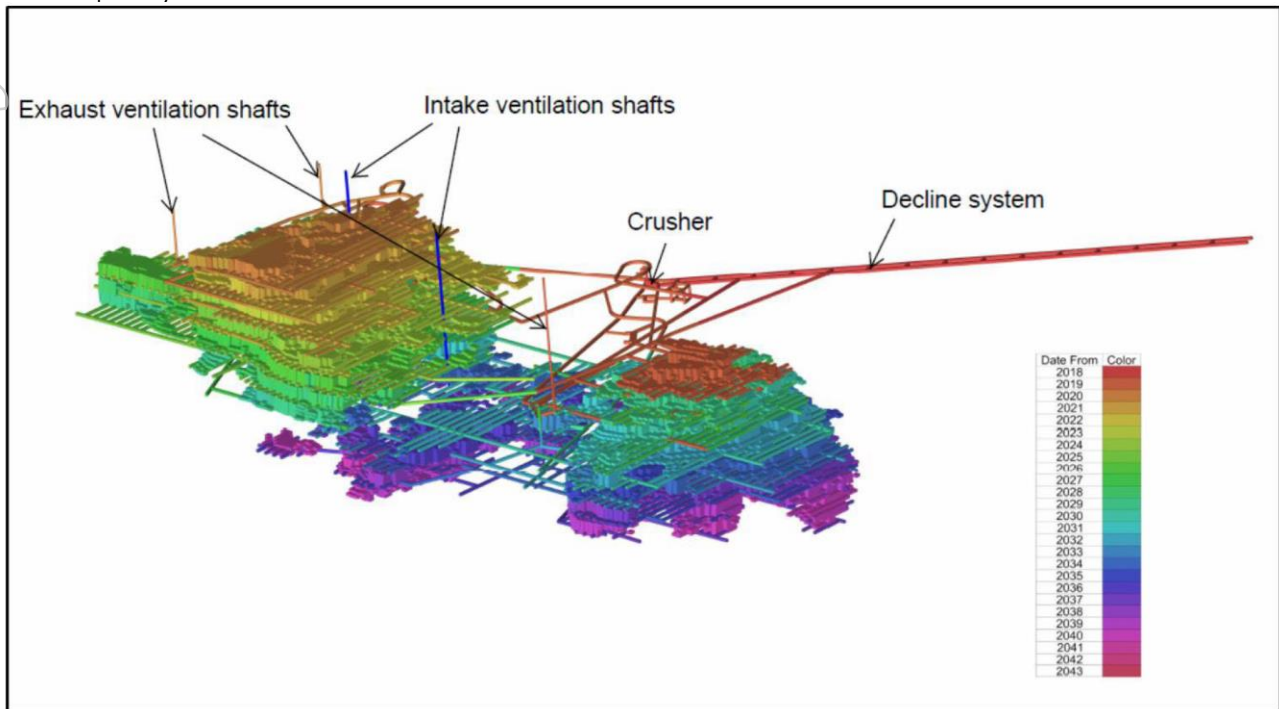

Figure 2 – 2019 PFS Update case mine design and schedule (long-hole open stoping with no fill).

In the 2017 PFS, only 52.4% of the total inventory could be extracted by long-hole open stoping with no fill, with the balance lost to rib and sill pillars around each stope.

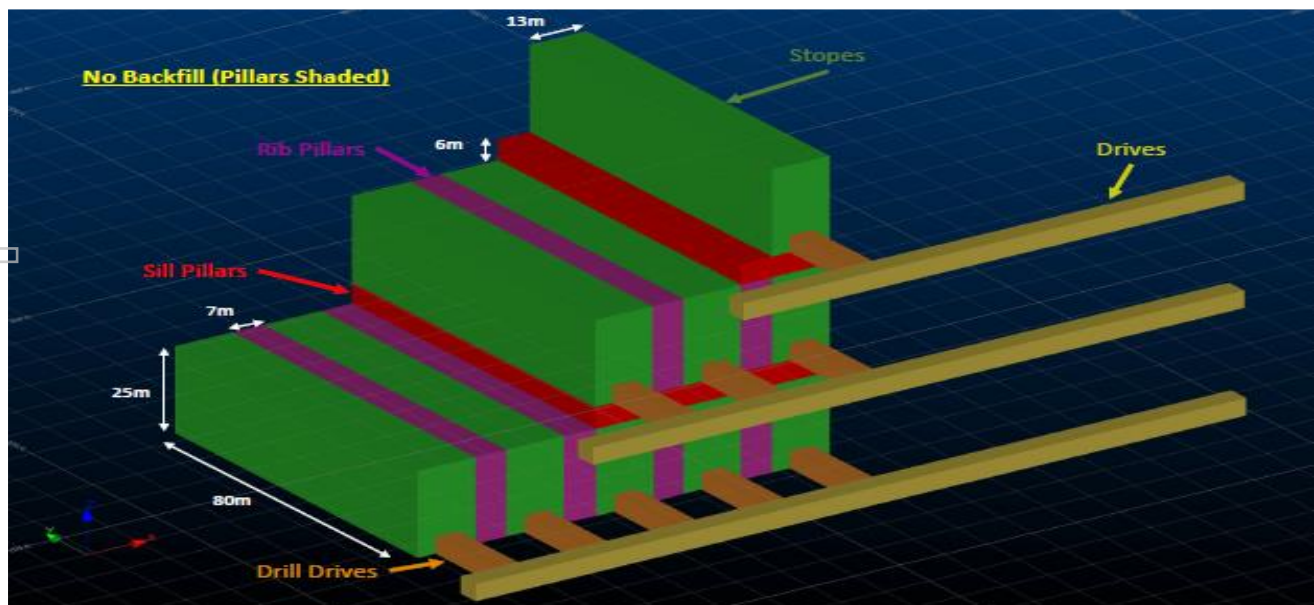

Figure 3 – 2019 PFS Update stope design schematic showing provision for 7m rib pillars every 13m, and 6m sill pillars every 25m for stability of 80m-long stopes.

Support requirements for non-stoping areas including the main decline, footwall drives, crosscuts and passing bays also remain the same.

For personal use only

In terms of geotechnical considerations for stoping, the latest geotechnical data made available by Geomet was used. Evaluation of regional ground conditions, hydraulic radii, stoping dimensions and pillar requirements suggested that rib, sill and potentially regional pillar requirements can be significantly reduced through the introduction of backfill.

Geotechnical assessment suggested that the introduction of a typical paste backfill could eliminate rib pillars and reduce the thickness of sill pillars between sublevels to 4m, effectively allowing insertion of additional stopes and increasing the extraction ratio (Figure 4).

Typically, paste fill (PF) allows for a stronger, stiffer fill when compared to the equivalent cemented hydraulic fill (CHF) thus higher extraction ratios can be achieved. Note that not all pillars can be eliminated as the retention of sill pillars and crown pillars, as well as selected rib pillars (or non-pay areas) for regional stability is still recommended. Fill requirements were calculated from the relative extraction ratios of each of these scenarios against the production target as determined in the 2017 PFS.

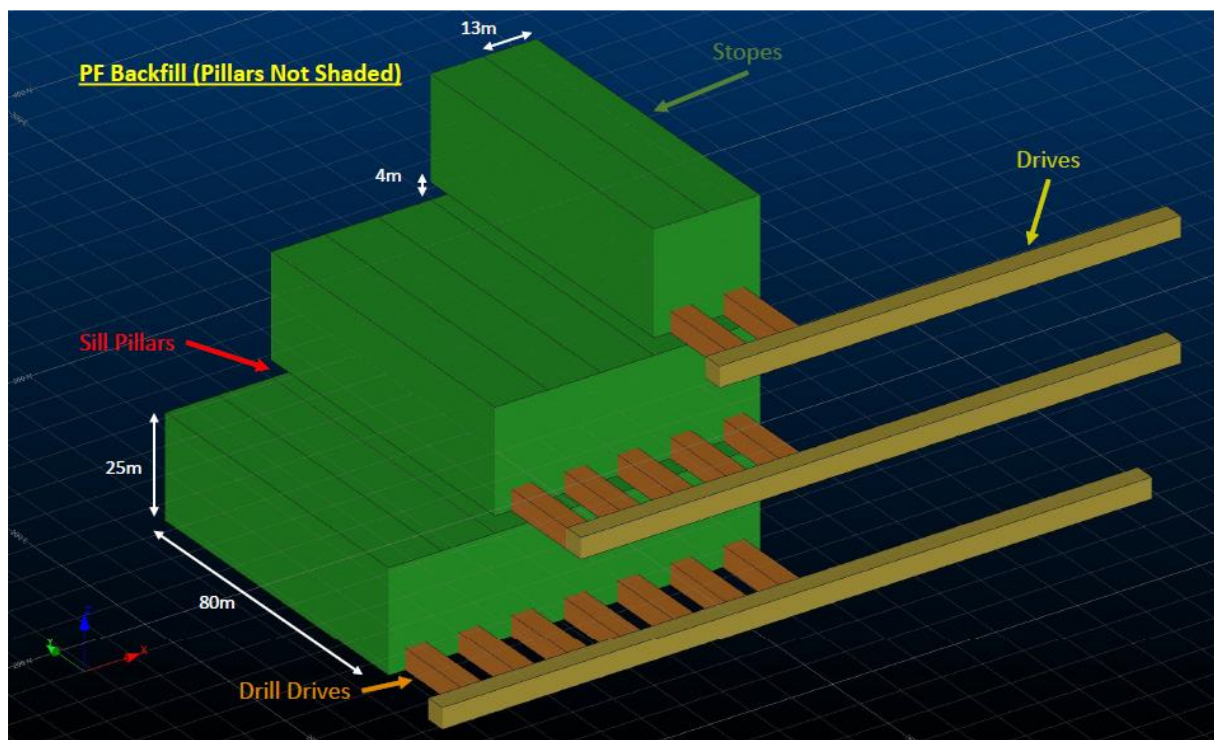

Figure 4 – PFS stope design schematic showing elimination of all rib pillars, with 4m sill pillars every 25m for stability of 80m-long stopes, with the effective addition of two entire stopes per level per the layout shown. Resulting extraction is calculated at 77.1% of the available inventory.

Updated mining physicals were generated as part of this 2022 PFS Update (Table 2).

Production/Operational Metric	Unit	2019 PFS Update case	2022 PFS Update Case
		Value	Value
Total Inventory			

For personal use only

- tonnage	Mt	34.5	54.5
- average LOM Li grade (Li %)	%Li	0.30	0.28
- average LOM Sn grade (Sn%)	%Sn	0.09	0.06
- average LOM W grade (W%)	%W	0.03	0.02
- Li LOM tonnes	t	104,377	153,319
- Sn LOM tonnes	t	31,812	33,421
- W LOM tonnes	t	11,906	12,255
Annual Production (excl. buildup)	Mt	1.69	2.25
Life of Mine	yrs	21.0	25
Percentage Extraction	%	52.4	77.1
Backfill Volume Required	Mm ³	-	18.5

Table 2: Updated Mining Physicals, 2022 PFS Update

Underground Infrastructure

Underground infrastructure provided takes into consideration the life of mine plan to support the underground mining production and development activities. Underground infrastructure comprises:

- Mine service water systems;
- Mine dewatering systems, including clean and dirty water pump stations;
- Mine electrical reticulation;
- Control systems and instrumentation;
- Trackless workshops;
- Refuelling bays; and
- Underground crushers, tips, and conveyors.

In addition, the 2022 PFS Update includes backfill delivery infrastructure and fill fencing.

Surface Infrastructure

Surface infrastructure supports the mine plan with consideration of the labour and mechanised equipment requirements of the operation in addition to the movement of rock, mineworkers and materials. The infrastructure is divided into two distinct areas, with the area at the portal servicing the initial development requirements and the second servicing the production phase.

Additional requirements for the preparation of fill, including classification of tailings, pumping of the required volume of tailings from the plant location to the backfill location, preparation of the fill in the backfill plant, and reticulation of fill to the stopes that require filling in accordance with the mining schedule were considered. A preliminary design for the paste fill plant was considered in the study (Figure 5).

For personal use only

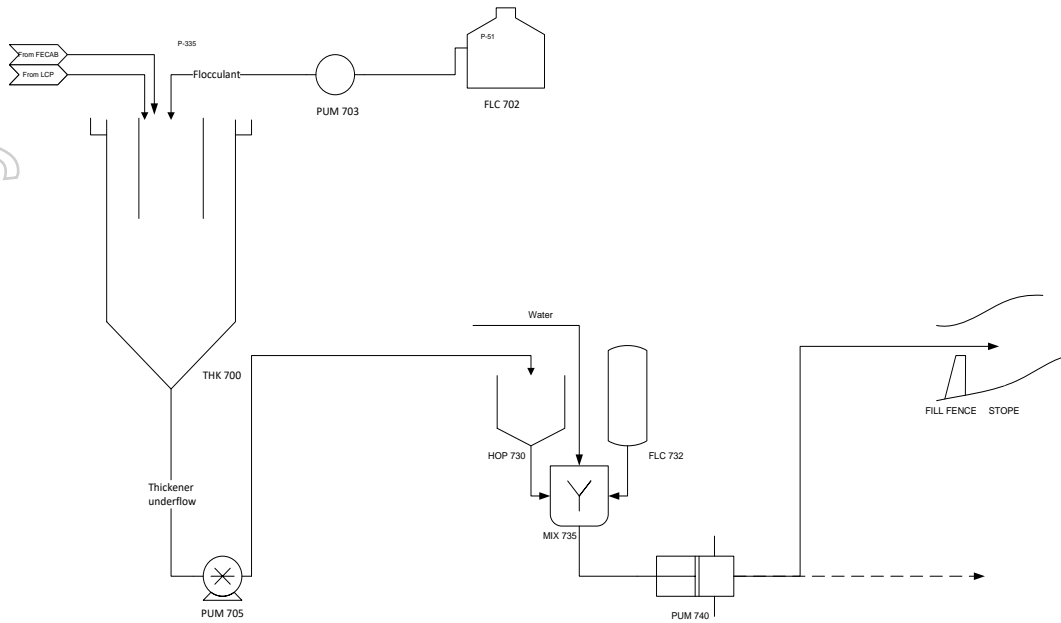

Figure 5 – 600,000 tpa paste fill plant design

A key aspect considered was the proposed location of the process plant some 9km away from and 450m downhill from the proposed paste fill plant location. A conceptual design for the pumping and piping of fill from the plant site back to the Cinovec portal area, as well as preparation, and distribution of paste fill to the various stopes in the schedule was prepared. Prefeasibility level (+/-25%) capital and operating cost estimates for both the PF plant and material handling were also prepared.

A schematic of the proposed mine sequence and schedule is shown in Figure 6. Proposed mining tonnages and grades are shown in Figure 7.

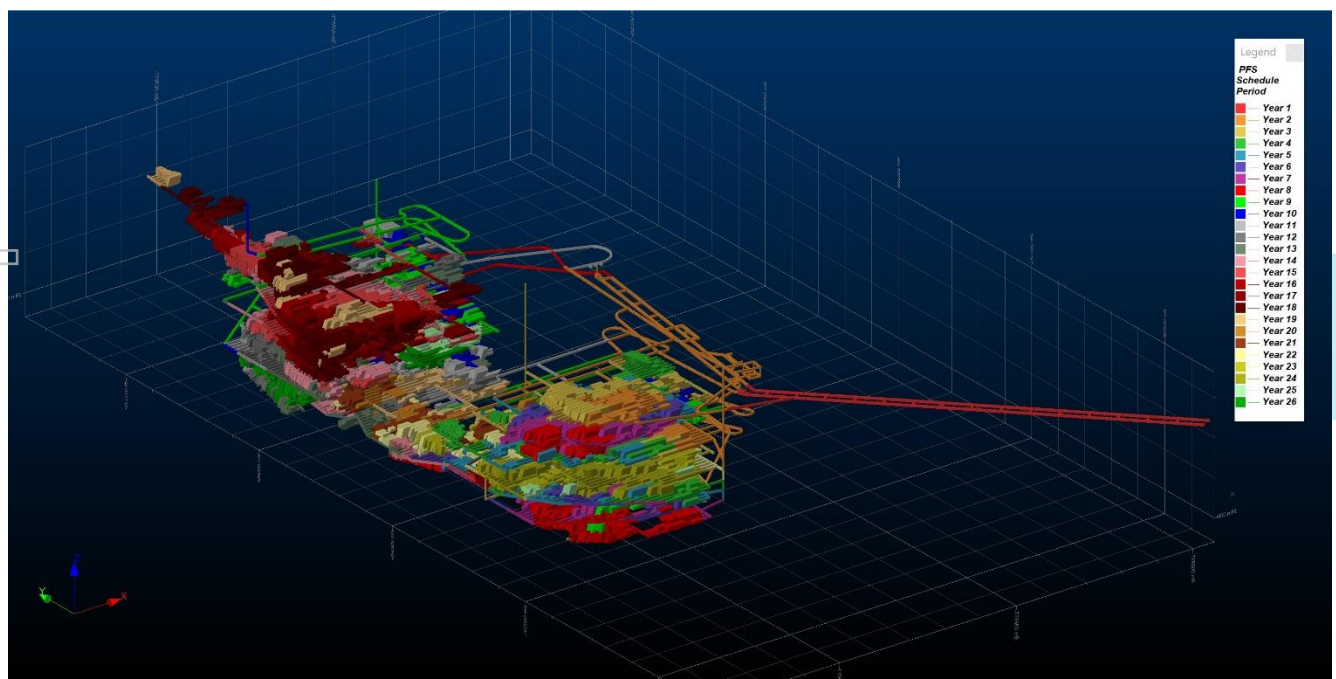

Figure 6: Mine Design and Stopping Sequence

For personal use only

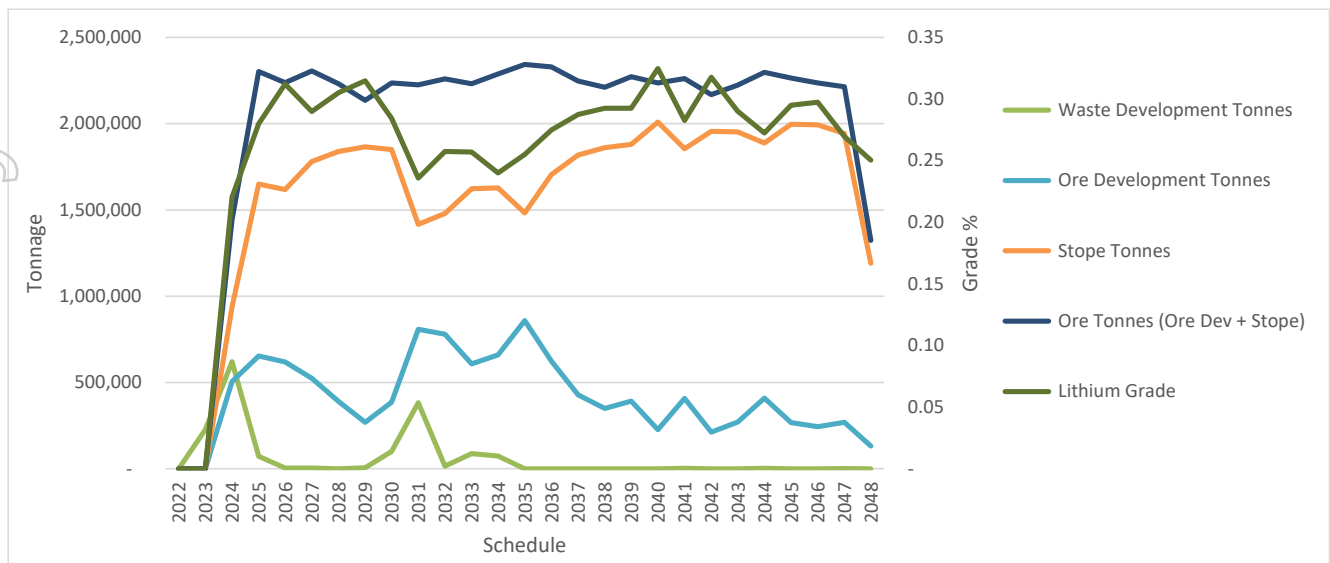

Figure 7: Life of Mine Grade and Tonnages for 2022 PFS Update

Processing

In the base case of the 2019 PFS Update, mining was scheduled to deliver a constant feed of 360,000 tonnes per annum of mica concentrate to the Lithium Chemical Plant (LCP). A maximum of 450,000 tpa is now anticipated. The processing approach considered in the 2019 PFS Update remains the same in this 2022 PFS Update, comprising grinding and magnetic separation (in the FECAB), followed by roasting and leaching of the mica concentrate, precipitation of a lithium carbonate intermediate (in the LCP), then conversion to lithium hydroxide in a second stage. However overall plant capacity is now increased from 1,680,000 tpa ore nominal to 2,250,000 tpa ore nominal. Capital requirements for the increased capacity were assessed. Impact on operating costs as a result of potential economies of scale for the production of lithium hydroxide were also considered.

Roasting & Lithium Hydroxide Process Test-work

Test-work was conducted over several months in 2019 primarily at Dorfner Anzaplan, Germany on lithium hydroxide production process development as well as earlier roasting confirmation test-work. This test-work was reported on 28 March 2018, 11 July 2018, 4 September 2018 and 8 April 2019.

The results from the early roasting test-work yielded up to 95% lithium extraction and were ultimately replicated in three separate laboratories. The changed reagent mix in the roasting process involved the substitution of waste gypsum ($\text{CaSO}_4 \cdot 2\text{H}_2\text{O}$) from European power stations as the primary source of sulphate for the roasting reactions, the addition of limestone at an approximate ratio of 1:10 (limestone to concentrate) as well as the recirculation of excess sodium sulphate to the roast feed mix. This reagent mix not only produced an increase in lithium recovery but also substituted cost effective reagents for the more expensive addition of hydrated lime and purchased sodium sulphate contemplated in the 2017 PFS.

The remainder of the test-work in 2019 was focussed on developing process flowsheet alternatives that would enable production of battery grade lithium hydroxide. The following results were outlined on 8 April 2019.

A series of tests were completed by Dorfner Anzaplan in Germany looking initially at the direct production of lithium hydroxide from leach liquors and subsequently testing a more traditional route of converting lithium carbonate into lithium hydroxide.

For personal use only

While both process routes were successful in producing battery grade lithium hydroxide, assessment of the relevant process risks indicated that the more robust flowsheet involved the production of battery grade lithium carbonate followed by conversion to battery grade lithium hydroxide.

The composition of the material produced compared with a typical industry specification is detailed in the Table 3.

Deleterious Species	Typical maximum Specification (ppm)	EMH (ppm)
Na	50	<1
K	50	<1
Cl	30	<15
SO4	100	~51
Fe	7	<1

Table 3: Cinovec lithium hydroxide comparison to typical specification

The engineering assessment was conducted using a 4.3 kg sample of lithium concentrate taken from a stock of historic ore samples taken from various sites in the Cinovec deposit. The sample was subjected to roasting after mixing with sodium sulphate, gypsum and limestone to a prescribed ratio, water leached, various steps of purification undertaken finally rendering a battery grade lithium hydroxide laboratory scale sample upon completion.

The result of the test-work was the production of a sample of battery grade lithium hydroxide. The work concentrated on the grade of product produced and not recovery rates. The total amount of product produced was below 10 grammes. Further information regarding the sampling techniques and data is set out in the tables annexed to this announcement.

Finally, it was reported on 19 April 2017 that at that time ongoing test-work was focused on fluoride and silica removal. This work was successfully completed to “proof of concept stage” during the production of battery grade lithium hydroxide in 2018 whereby a portion of the fluoride dissolved at the leaching stage was removed when lime was introduced at the initial purification step after the water leach and then activated alumina was utilised to reduce the remaining fluoride concentration prior to lithium carbonate production to acceptable levels which then flowed through to the lithium hydroxide product.

Recovery results

Based on detailed analysis of the test-work results, specific recovery algorithms were developed and entered directly into each block in the block model used for mine scheduling. The average metallurgical recoveries used in the project financial model are summarised below:

- Lithium recovery to concentrate 90%
- Lithium recovery in carbonate plant 91%
- Overall lithium recovery – 82%
- Tin recovery 65%

For personal use only

Comminution Plant

The purpose of the Comminution Plant (Figure 8) is to reduce the size of the ROM ore to a particle size distribution (**PSD**) that optimises lithium recovery, whilst allowing efficient pumping to the Beneficiation Plant.

Primary crushed ore is delivered to the Coarse Ore Stockpile. The ore is milled to 250 μm in a single stage SAG mill.

The Comminution Plant is run water neutral to remove the need for make-up water or disposal at the mine-site location. This is achieved by returning water from the Beneficiation Plant via a pipeline. Thus, the comminution plant has the advantage of operating at zero water discharge.

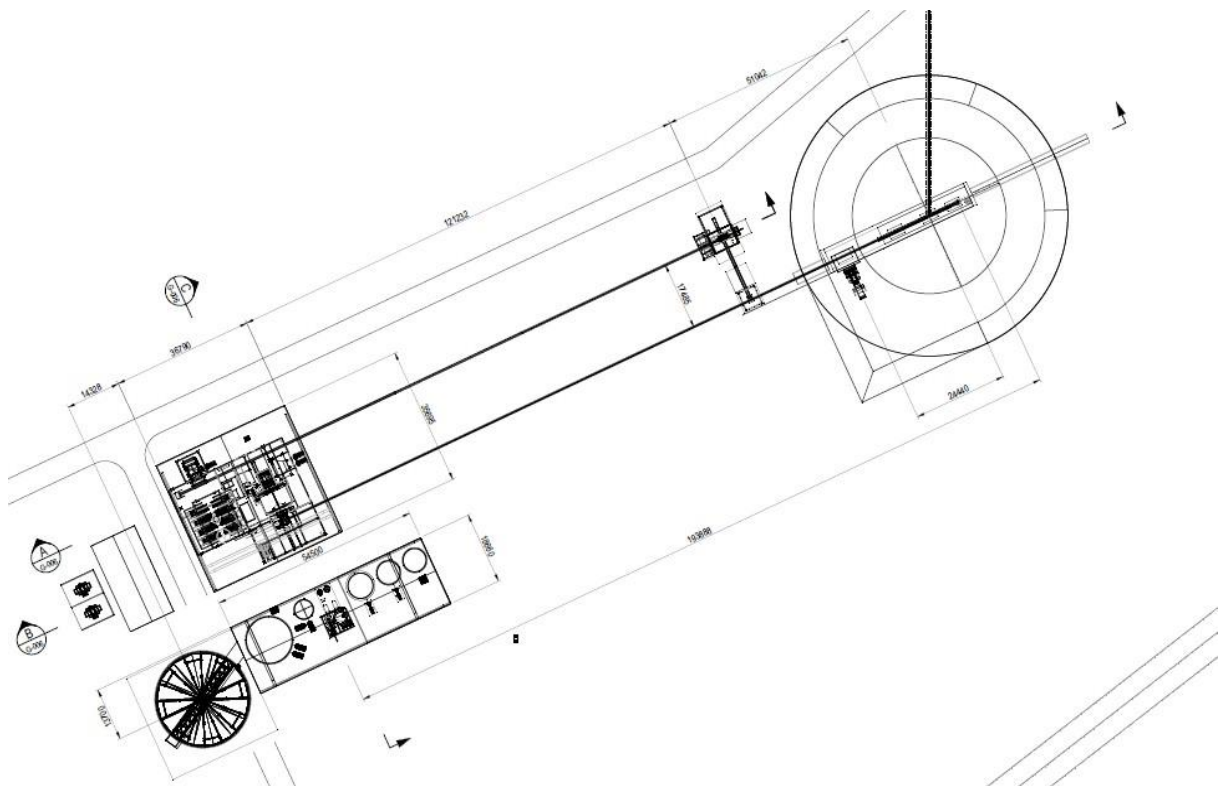

Figure 8: Comminution Plant Layout

The layout of the Comminution Plant maximises the use of the flat land available upon the top of the ridge, shortening the overall footprint. Room has been allowed for future pebble crushing in the SAG mill recirculating load, to allow for retrofitting if conditions warrant.

Beneficiation Plant

The Beneficiation Plant has two functions:

- (i) First, to magnetically separate the paramagnetic zinnwaldite to produce a lithium rich magnetic stream (mica-concentrate) to feed the downstream lithium carbonate plant; and
- (ii) Second, to then treat the non-magnetics by-product stream with gravity, flotation, magnetic

For personal use only

and electrostatic separation to produce tin and tungsten product. Filtered tailings are produced for storage in the Tailings Storage Facility (TSF).

The layout of the Beneficiation Plant is shown in Figure 9.

Magnetic Circuit

Milled product from the Comminution Plant received via the overland pipeline is stored in the magnetic circuit feed tank. The tank is agitated and acts as a buffer between the Beneficiation Plant and the overland pipeline. The pipeline slurry density is 56% to 58% solids, whilst the discharge density required by the Low Intensity Magnetic Separation (LIMS) is 40% solids. The LIMS magnets reject ferromagnetic species from the slurry prior to the multi-stage Wet High Intensity Magnetic Separation (WHIMS) process.

The WHIMS circuit features a rougher, cleaner, scavenger arrangement. The scavenger removes the non-magnetic material from the rougher and cleaner units and returns the magnetic fraction back to the start of the circuit to improve mica recoveries.

The cleaner magnetic fraction is reground in closed circuit with a spiral to reduce the PSD to required LCP feed size. Any tin which is liberated in the process is recovered from the mica-concentrate by the spirals.

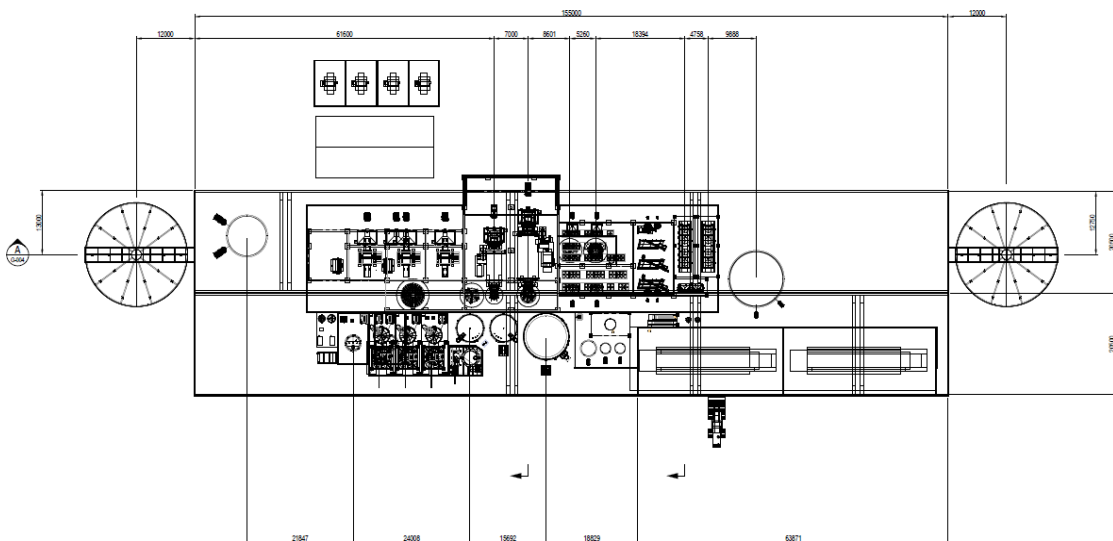

Figure 9: Beneficiation Plant Layout

Non-magnetics Gravity Circuit

The Non-Magnetics Gravity Circuit treats the by-product stream from the Magnetic Separation Circuit's concentrating the tin and tungsten minerals for feeding to the Tin Dressing Circuit, where the final by-product streams are produced. The circuit also has the ability to receive tin and tungsten gravity concentrate as slurry from the LCP.

The circuit incorporates three stages of classification with:

- The coarse fraction is treated by two stages of spirals and two stages of wet tables and also incorporates a regrind mill which is used to achieve the required liberation size of the tin and tungsten minerals;
- The medium sized fraction is treated by two stages of spirals and two stages of wet tables;
- The finer fraction is treated with a flotation and high gravity concentrator; and

For personal use only

- The finest fraction, slimes, is rejected to final tails.

The concentrate produced from the gravity circuit is sent for dressing whilst the tails are dewatered via a thickener and filter.

The dressing circuit upgrades the concentrates through sulphide flotation. Electrostatic precipitation is then used to separate wolframite and cassiterite from the scheelite. Dry magnetics separate the wolframite from the cassiterite to give the final saleable tungsten and tin concentrates.

FECAB Tailings Test-work

Rheology and geochemical work was conducted on various tailings streams. The tests concluded:

- Samples had a definite, but very low level of radioactivity. No U or Th were detected in the SPLP leach; and
- Samples were devoid of sulphides and have no potential to generate acid-mine drainage as confirmed through both the ABA and NAG test. However, the neutralisation potential of samples was also very low and samples also had a very low total carbon content.

Lithium Hydroxide Process Facilities Design

The flowsheet that was developed for the production of battery grade lithium hydroxide on the back of the results from the test-work described previously is shown in Figure 10. The significant points in the design include:

- The roasting operation will be completed in a rotary kiln;
- The roaster receives a slurry of mica concentrate from the FECAB plant via pipeline;
- The concentrate slurry is dewatered and stored in a covered stockpile to create a buffer between the FECAB and the lithium production facility;
- The concentrate is mixed with limestone, waste gypsum and recycled sodium sulphate before roasting to convert the lithium into a lithium potassium sulphate in the hot calcine which is initially cooled in a rotary cooler, discharged into a small ball mill to ensure that larger particles in the calcine are sufficiently reduced in size and then leached to achieve the dissolution of the contained lithium sulphate values;
- The leached slurry is filtered on one of two belt filters to separate the pregnant leach solution from the residue;
- The leach solution undergoes impurity removal steps to remove calcium, magnesium, fluoride and silica by precipitation and adsorption. Sodium sulphate is then recovered from the leach solution (as Glauber's Salt) by cooling. The Glauber's salt is melted and then crystallised as anhydrous sodium sulphate for recycling back to the roaster feed and/or sale as a by-product;
- Crude lithium carbonate is then precipitated from the purified leach solution through alum precipitation which produces a rubidium rich residue, evaporation, fluoride removal through interaction with activated alumina and addition of sodium carbonate;
- The crude lithium carbonate is then re-dissolved through the addition of carbon dioxide to form lithium bicarbonate. The lithium bicarbonate solution is subsequently filtered and purified through an ion exchange process before pure lithium carbonate is re-crystallised by heating the solution causing the lithium bicarbonate to decompose;
- Potassium sulphate is produced as a by-product from the production of lithium carbonate through initially the recovery of glaserite from the crude lithium carbonate filtrate and subsequent formation of potassium sulphate which is dried and packaged for sale and the remaining sodium sulphate containing solution is recycled back into the process; and

- The flowsheet described in this report then takes the battery grade lithium carbonate through further processing steps to produce battery grade lithium hydroxide. Lithium hydroxide solution is formed initially through conversion with hydrated lime slurry followed by a final purification step involving ion exchange, then lithium hydroxide crystallisation, solids recovery, drying and packaging for sale.

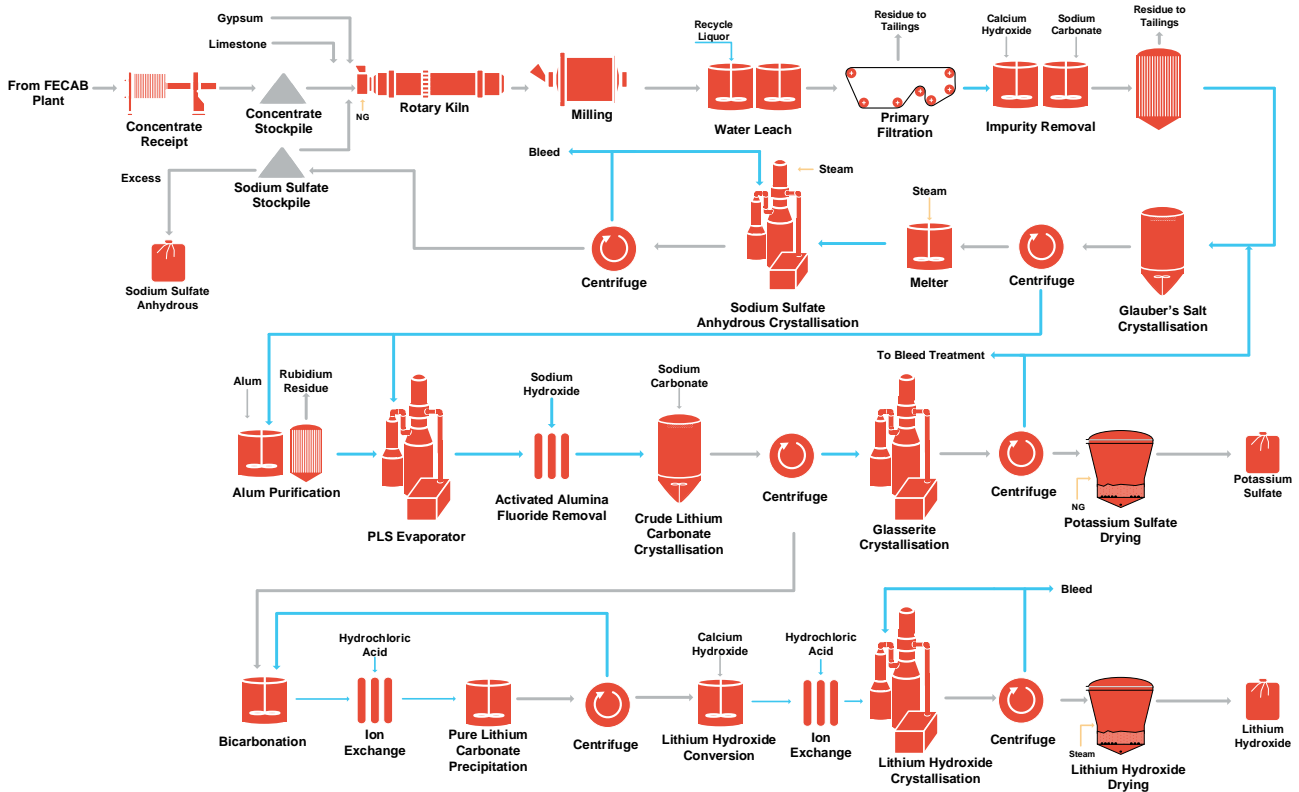

Figure 10: Cinovec lithium hydroxide Conversion Process Schematic

Tailings

The 2019 PFS Update was based upon all the processing tailings produced by the beneficiation and lithium carbonate plants being pressed into filter cakes to allow dry stack impoundment a close distance from the processing plants. Tailings consists of approximately 1.7 Mtpa of FECAB material and 0.43 Mtpa of LCP material (mostly leach residue).

In this 2022 PFS update an average of 600,000 tpa tailings comprising a proposed mix of LCP tailings and FECAB tailings is scheduled for preparation of paste fill in the mining operation. The backfill schedule is calculated to consume the entirety of the LCP tailings volume with the balance made up from FECAB tailings.

The balance of FECAB tailings is proposed to be filtered and conveyed as appropriate to a dry-stacked type tailings management facility.

Although dry stacking is the more expensive compared to traditional wet deposition, it was chosen due to the following advantages:

For personal use only

- The higher safety factors associated with the design versus conventional storage facilities. The region has historic high levels of rainfall thus dry stacking reduces the amount of water to treat by reducing the Tailing Storage Facility (**TSF**) footprint;
- Progressive rehabilitation is possible, spreading the cost of closure over a longer time when compared to conventional storage facilities; and
- Filtered tailings allow better recovery of lithium by recovering more liquor.

Filtered tailings will be filtered and dumped onto a pad. Wheel loaders and articulated trucks or rail will transport the tailings to a TSF for impoundment.

An initial TSF cell was designed to accommodate the first two years of combined tailings, with the associated capital cost included in the capital estimate. The TSF was lined and featured water collection and diesel powered decant pumps for returning any run off water to the processing plant. This is no longer envisaged to be required and could result in costs savings in the feasibility study.

Significant impact to tailings requirements is anticipated with the move to the backfilled mining plan. In the 2019 PFS, tailings management requirements are for 20Mm³ of combined FECAB and LCP tailings. In this 2022 PFS Update, total tailings generated increases to 33 Mm³. However, paste backfill is anticipated to be a 50:50 combination of FECAB and LCP tailings, from which 18.5Mm³ is required over the updated life of mine. A reduced volume of 14.5Mm³ therefore remains for disposal.

Environmental

The Cinovec Project is governed by Act No.100/2001 Coll., on Environment Impact Assessment (**EIA Act**). The competent authority is the Ministry of the Environment (Environment Impact Assessment Department) (**MOE**). An integrated permit is issued upon completion of the Environmental Impact Assessment (**EIA**) process.

The EIA documentation is required to be structured as follows:

- details concerning the notifier;
- details concerning the development project;
- details concerning the status of the environment in the region concerned;
- comprehensive characteristics and assessment of the project impacts on public health and the environment;
- a comparison of project versions (if any);
- a conclusion; and
- a commonly understood summary and annexes (opinion of the Building Authority, opinion of the Nature Protection Authority, expert studies and assessments).

The following expert studies and assessments must be compiled during the EIA Documentation preparation stage:

- noise impact study;
- air quality impact study;
- biological survey;
- human health impact study;
- transport impact study;
- landscape impact study; and
- water quality and hydrology impact study.

In this case, with respect to the location of the project at the border with Germany, an “international assessment” provision applies (Section 13 of the EIA Act).

The Company has commenced the EIA process with a baseline study, prepared by GET s.r.o. an independent Czech based environmental consultancy, which has identified the environmental areas to be assessed and determined preliminary outcomes.

The underground mine and surface portal is located on the border of or immediately adjacent to an environmentally sensitive area. From that perspective, the EIA will focus particularly on project impacts on European protected areas Natura 2000 (protected birds) and mine water discharge into surface streams. The Company has re-positioned key infrastructure to minimise impacts to both the environment and the community and has placed crushing facilities underground to minimise noise as well as enclosing the mill to further reduce noise and visual impacts. Considering the long-term mining history in the region and at the deposit itself, the project will not significantly impact the environment.

In April 2021, GEOMET s.r.o. submitted to the MOE a notification of intent to mine the Li-Sn-W ore deposit together with the relevant documentation with a comprehensive project description and an independent assessment of the impact of the project on Natura 2000 areas. The notification dossier was published by the MOE and the authorities concerned and the public were invited to comment (refer to the Company’s ASX release dated 6 May 2021). The Ministry received twenty comments from the authorities concerned and the public. On the basis of these, in August 2021, the MOE issued the conclusions of the screening procedure containing fifteen requests for additional studies and explanations. All of them contain standard requirements for the assessment of noise, emissions, transport loads, waste management, water protection, impact on animals, etc., taking into account measured data and data from the definitive feasibility study. As the DFS progresses, the Geomet is working on those assessments, which will then be submitted to the MOE and for public discussion.

CAPITAL COSTS

2019 PFS Update Lithium Hydroxide Production Capital Costs Estimate

Hatch Associates Pty Ltd (**Hatch**) completed the 2017 PFS for the sodium sulphate roast process treating lithium concentrate to produce lithium carbonate. In 2018, Hatch was engaged by EMH to modify the 2017 PFS to convert lithium carbonate to lithium hydroxide product and incorporate an updated roast design. This work was further supported in 2019 by additional test work conducted at Dorfner Anzplan. Hatch updated their report in the 2019 PFS Update to include capital and operating cost estimates for the production of lithium hydroxide.

In the 2017 PFS, the estimated capital cost of the Cinovec Project for the production of 20,800 tpa lithium carbonate was \$393 M based on Q1 CY2017 pricing. The accuracy of that estimate was considered at the time to be +/-25%. The capital cost estimate included all costs for design and construction of the plant and infrastructure on the site for the mine, FECAB and LCP. Allowances were made for connection to off-site services such as gas, electricity and water, construction of a tailings storage facility, project contingency and owners costs including project management team, project approvals, establishment of the operating team and commissioning.

In the 2019 PFS Update, a summary of the current project capital cost estimate for an average production rate of 25,267 tpa lithium hydroxide was presented as set out in Table 6. The capital cost estimate summarised in Table 6 has been derived from modifications to the capital cost estimate produced during 2017 PFS. The need for the significant modifications that were made, which for example resulted in the prediction that all equipment in the leaching and roasting sections could be reduced in size by approximately 10%, were determined after the completion of the 2019 PFS update. As a result, the SysCAD plant simulation model was revised to allow for confirmation that the envisaged changes were significant and to gain insight into the quantum of plant scale change that would result. As such the cost estimate from the 2017 PFS was factored using industry norms to reflect the 10%

reduction in size of the roasting, leaching and some reagent facilities resulting in an accuracy of +/- 30% for this portion of the plant. The total estimated capital cost to construct a facility for the production of 25,267 tpa lithium hydroxide was estimated to be \$483.4 M in the 2019 PFS Update, as detailed in Table 4 below.

Section	TOTAL US\$ M
Underground Mining Development	
Mining Directs	67.3
Mining Indirect Costs	3
Total Mining Cost	70.3
Front End Comminution & Beneficiation Plant (FECAB)	
Comminution – Direct	25.2
Beneficiation – Direct	40.5
Infrastructure – Direct	20.8
FECAB Indirect Costs	18.4
Total FECAB	104.9
Lithium Production Facility	
Production Plant Directs	213.8
Production Plant Indirect Costs	50.5
Total Lithium Production Plant	264.3
Overall Project Contingency @ 10%	43.9
TOTAL CAPITAL COST	483.4

Table 4: 2019 PFS Update Overall Project Development Capital Cost

Increase in Capital Cost as result of using Paste Backfill

The revised mining capex in this 2022 PFS Update makes provision for the backfill plant and all related infrastructure, which will be fully assessed by Paterson & Cooke during the mining DFS currently underway. Knight Piesold has been engaged by Bara Consulting to conduct the tailings storage assessment and design within the mining DFS.

Additional mining capital of \$32M was estimated for an expansion from 1,680,000 tpa nominal ROM to 2,250,000 tpa ROM. An estimate on upfront capital of \$27M for a 600,000 tpa paste plant located at the Cinovec mine portal was provided, plus \$11M for fill distribution infrastructure. An additional \$8M was allowed for a suitable pump station and pipeline delivering thickened FECAB and LCP tailings 9km uphill from the plant site to the portal. Additional capital of \$141.5M for a process plant expansion from 1.68Mtpa to 2.25Mtpa was also estimated, including incremental savings from a reduction in size of the tailings management facility.

As is customary for this type of study, this 2022 PFS Update was prepared to an overall level of accuracy of approximately $\pm 25\%$ for capital costs.

Capital Costs US\$m	2019 PFS update \$USM	2022 PFS Update \$USM
Mining incl. Infrastructure	70.3	113.9
Backfill plant & infrastructure	-	28.0
Processing incl. Indirects	369.2	448.6
Contingency	43.9	53.3
Upfront Capital	483.4	643.8

For personal use only

Sustaining Capital	-	151.0
Total Capital Costs	483.4	794.8
Annual average ore mined	1.69 mtpa	2.25 mtpa
Annual average LiOH.H ₂ O	25,267 tonnes	29,386 tonnes

Table 5: 2019 PFS Update Capital Costs updated for expanded mine plan and paste backfilling in 2022 PFS Update

OPERATING COSTS

2019 PFS Update Lithium Hydroxide Production Operating Costs

For the 2019 PFS Update, operating costs in the areas of mining, FECAB plant operation, tin and tungsten recovery or corporate office costs and other overheads were as per the 2017 PFS as there was limited inflation in the intervening period from the 2017 PFS. The only operating costs that were estimated by Hatch in the 2019 PFS Update were those specifically for the production of lithium hydroxide. The costs in the 2019 PFS Update were based on an average production rate modelled in EMH's SysCAD plant simulation model of 25,267 tpa lithium hydroxide (LiOH.H₂O) which is equivalent to 22,259 tpa of lithium carbonate, as detailed in Table 6 below.

Average Operating Cost (yr. 3-20)	\$M pa	\$t / ROM	\$t / LiOH	% Op Cost
Mining	40.7	24.3	1,625	33%
FECAB	19.4	11.6	770	16%
LiOH Plant	62.1	37.0	2,458	50%
Overall Project Admin	0.9	0.5	34	1%
Total Operating Cost	123.1	73.4	4,876	

By-product Revenue Credits	\$M pa	\$t / ROM	\$t / LiOH
Sn/W (yr3-20)	29.2	17.4	1,156
Potash & sodium sulphate	7.8	4.6	285
<i>Excluding Sn/W Royalties & Transportation Cost</i>			
Total Opex (Net of By-product Credits)	86.1	51.4	3,435

Table 6: 2019 PFS Update Average Project Operating Cost

The maintenance costs used in the operating cost modelling includes requirements for sustaining capex. The cost of tailings impoundment is included in the above numbers.

2022 PFS Update - Operating Costs

Mining costs per ROM tonne remain unchanged from the 2019 PFS Update. Additional operating costs for backfilling at \$4.70/t ROM were estimated. Process operating costs as well as general and administrative costs (G&A) were re-estimated for a ROM throughput of 2.25Mtpa vs. the 1.68Mtpa in the 2019 PFS. Total process opex is now \$41/t including G&A. A revised tailings disposal cost of \$11.75/t to allow for filtration, transport and disposal of tailings at the proposed tailings storage site was estimated. Costs for the transportation of lithium, tin, tungsten and potash concentrates to an appropriate port for export FOB of \$60/dmt were also assessed.

As is customary for this type of study, this 2022 PFS Update was prepared to an overall level of accuracy of approximately ±25% for operating cost.

For personal use only

US\$/t Costs	2019 PFS Update US\$/t Costs	2022 PFS Update US\$/ROM † Costs
Mining	24.30	25.48
Tailings management	1.40	11.75
Backfill plant & infrastructure	-	4.70
Processing incl G&A	47.70	41.00
LiOH.H ₂ O Transport	-	1.32
Total	73.40	84.25

Table 7: Annual Operating Costs per tonne of ore mined

Average Operating Cost (yr. 3-25)	\$M pa	\$t / ROM	\$t / LiOH	% Op Cost
Mining	65.8	24.3	2282	34
Tailings Management	25.6	11.7	888	13
Backfill plant & Infrastructure	10.3	4.7	355	5.2
Processing + Admin	89.5	41	3103	46
Concentrate Transport	2.8	1.3	99	1.4
Total Operating Cost	194	83	6727	100

By-product Revenue Credits	\$M pa	\$t / ROM	\$t / LiOH
Sn/W (yr3-2 0)	24	11.1	880
Potash	8.1	3.7	280
<i>Excluding Sn/W Royalties & Transportation Cost</i>			
Total Opex (Net of By-product Credits)	162	68.2	5567

Table 8: 2022 PFS Update Average Project Operating Cost
LITHIUM HYDROXIDE PRODUCTION FINANCIAL SUMMARY
Update to the Commodity Prices as at January 2022

This 2022 PFS Update revised the end-product sales prices from the numbers contained in the 2019 PFS Update for lithium hydroxide monohydrate and for by-products, tin and tungsten concentrates and potassium sulphate to the current long term prices as set out in the table 9 below.

US\$/t	Original Pricing in the 2019 PFS Update	January 2022 Long-Term Price
Lithium hydroxide monohydrate	12,000	17,000
Tin	22,500	24,000
Tungsten	33,000	30,300
Potassium Sulphate	520	520

Table 9: Pricing Assumptions

The Lithium price is the key driver of the Project. In arriving at forecast pricing for battery grade lithium hydroxide the Company has considered the outlook presented by a number of key industry groups, including Benchmark Mineral Intelligence, S&P Global, Metal Bulletin and Fastmarkets, a number of globally respected investment banks including JP Morgan and Macquarie as well as price forecasts

recently announced by other lithium project developers and has concluded that the price at which the NPV calculated in the 2019 PFS Update does not accurately reflect the current long-term price of battery grade lithium hydroxide. The Company further considers that an update of the NPV based upon the current long-term price and the very positive long-term outlook for lithium prices, particularly when compared to the prices at the time of the 2019 PFS Update, is required to ensure that the market is adequately informed about the prospects of the Cinovec project being undertaken and completed.

Based upon this, Geomet and EMH have assumed a long-term price for lithium hydroxide of \$17,000 per tonne and have used this to revise the NPV of the Cinovec Project.

Effect on NPV

The alteration of the pricing assumptions in this 2022 PFS Update to the current long-term prices set out in Table 9 and the increase in production from 1.68Mtpa to 2.25Mtpa results in an increase in the NPV to \$1.938B.

Demand for Lithium

Benchmark have recently published an update to its supply and demand forecasts which gives a clear indication of the growing need for lithium.

Lithium and the great raw material disconnect

The gap between operating mines and demand in 2030 will be ~2Mt LCE, this is 5x higher than the entire market in 2021

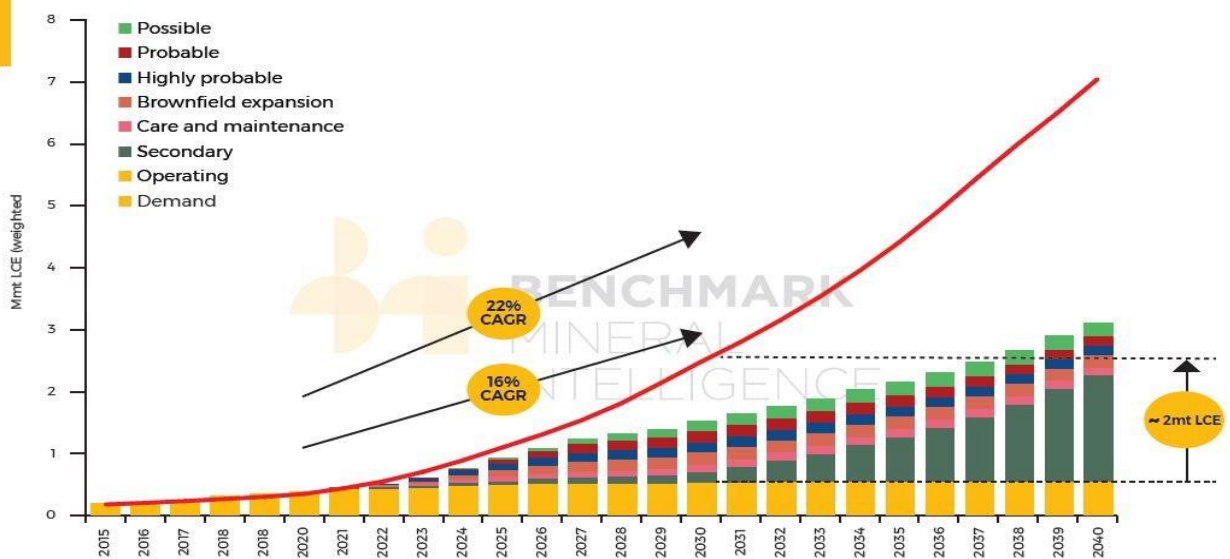

Source: Benchmark Forecasts
Contact us at: benchmarkminerals.com

Figure 11: Benchmark Li Supply/Demand Chart – 2021

For personal use only

World Lithium Ion Megafactory Capacity 2010-2030

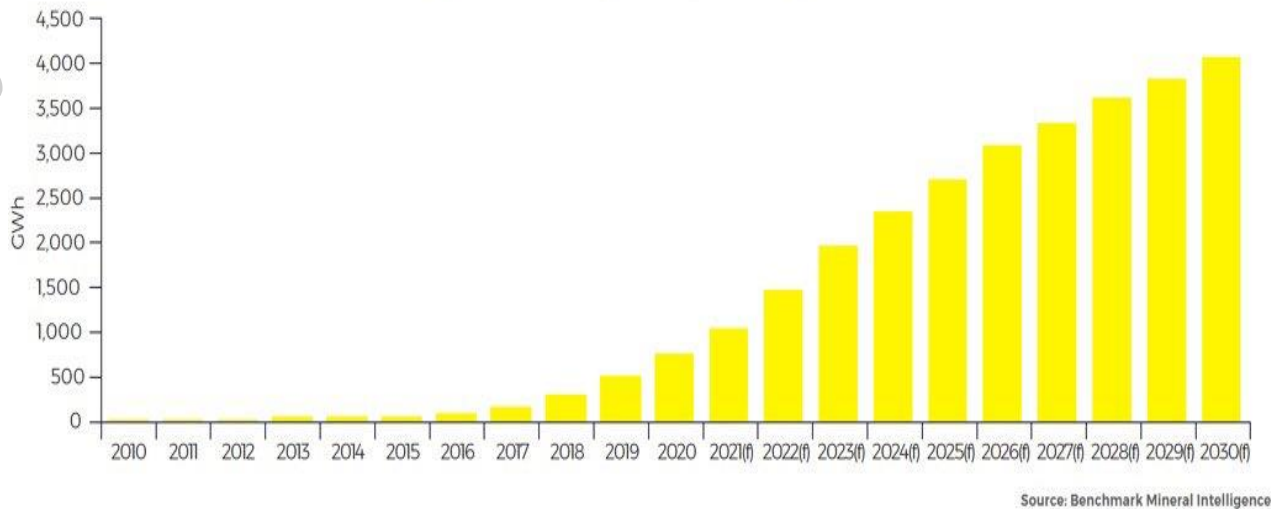

Figure 12: Benchmark Li Ion Megafactory Capacity – 2010-2030

Tax is calculated at 19% and a 10-year tax free window has been applied as provided for by Czech investment legislation for projects of this scope.

Metric	Value	Metric	Value
NPV @8% Discount	\$1,108 M	Average LiOH Production rate	25,267 tpa
IRR (Post tax)	28.8 %	Avg Production Cost (without credits)	\$4,876 /t LiOH
Capital Expenditure	\$482.6 M	Avg Production Cost (with credits)	\$3,435 /t LiOH
Total Mined Ore	34.4 Mt	Avg Mill Rate (yr. 3-20)	1.68 Mtpa
Peak Mill Feed	1.8 Mtpa	Life of Mine	21 years

Table 10: 2019 PFS Update Project Financial Summary

Metric	Value	Metric	Value
NPV @8% Discount	\$1.94B	Average LiOH Production rate (tpa)	29,386
IRR (Post tax)	36%	Avg Production Cost (without credits)	\$6,727
Capital Expenditure	\$644M	Avg Production Cost (with credits)	\$5,567
Total Mined Ore	54.5Mt	Avg Mill Rate (yr. 2-25)	2.25 Mtpa
Peak Mill Feed	2.34Mtpa	Life of Mine	25 years

Table 11: 2022 PFS Update Project Financial Summary

Sensitivity Analysis

A sensitivity analysis shows lithium pricing has the most impact on the project.

For personal use only

For personal use only

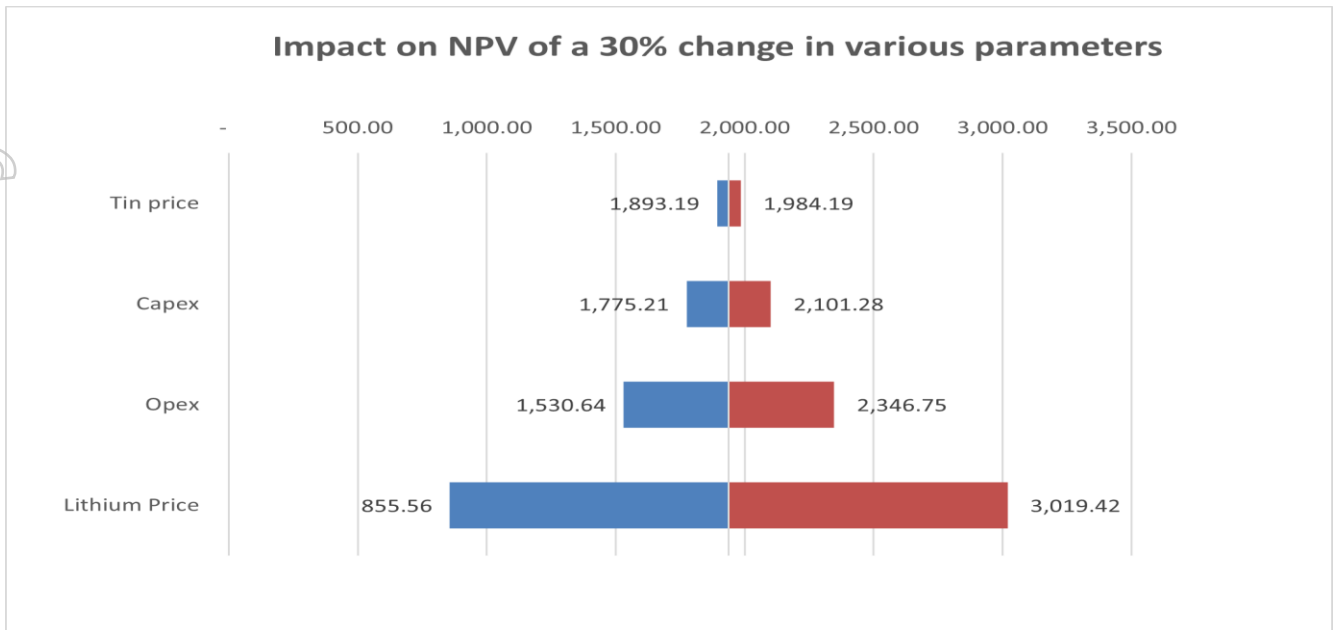

Figure 13: Sensitivity Analysis

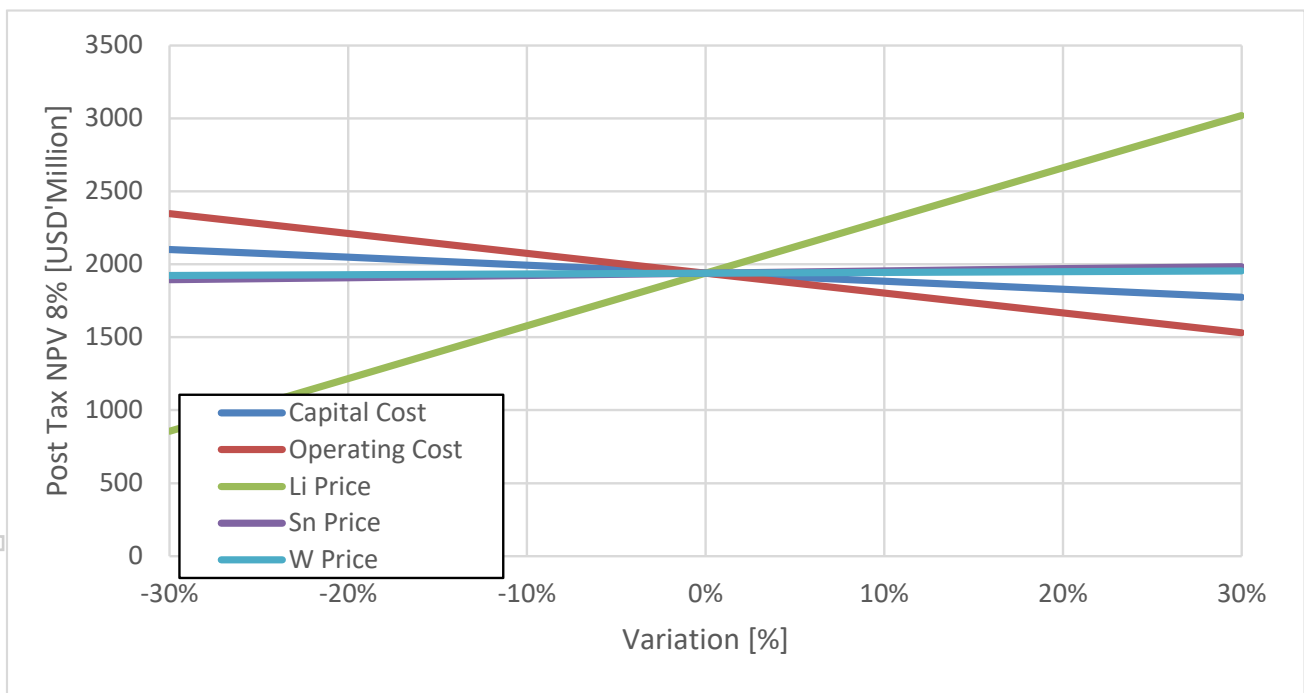

Figure 14: Sensitivity Analysis

As is customary for this type of study, this 2022 PFS Update was prepared to an overall level of accuracy of approximately $\pm 25\%$ for capital and operating costs.

PROJECT FINANCING

The Company does not currently have the financial capacity to internally fund its 49% interest of the development of the Cinovec Project. External funding as a mix of debt and/or equity will be required. Based upon an assumption of 70% debt/30% equity, the debt funding required by Geomet will be

approximately \$450M and the EMH portion of the equity required (49%) will be approximately \$95M. In parallel with ongoing work programs pertaining to realising value from the Cinovec Project, the Company is continuing to evaluate its financing strategy with the objective of minimising dilution for existing shareholders. Shareholders should be aware that further equity funding may be required for the future funding for development of the Cinovec Project, and if so, their ownership of the Company or the Company's economic interest in the Cinovec Project may be diluted.

The Company has engaged advisors and has had preliminary discussions with financiers to understand the debt carrying parameters of the project. Release of this 2022 PFS Update provides a stronger platform for the Company to advance discussions with potential finance providers and/or JV partners. On the basis of the robust market outlook for lithium products and preliminary work already undertaken in relation to financing, the Company considers that there is a reasonable basis that the development of the Cinovec project can be successfully funded.

Notes Specific to ASX and AIM Announcements

The following announcements were lodged with the ASX and published via RNS in the UK, and further details (including supporting JORC Reporting Tables) for each of the sections noted in this announcement can be found in the following releases:

- 19 April 2017 - PFS study confirms Cinovec as potentially low-cost lithium carbonate producer
- 28 March 2018 - Lithium Recoveries Improved to 95%;
- 11 July 2018 - Cinovec Production Modelled to Increase to 22,500 TPA LCE – 11 July 2018;
- 4 September 2018 - Cinovec Project Update – Significant Achievements – 4 September 2018;
- 8 April 2019 - Cinovec project update – Battery grade lithium hydroxide produced; and
- 8 April 2019 - Battery Grade Lithium Hydroxide Produced – Clarification – 8 April 2019
- 17 Jun 2019 - PFS Update Confirms Potential Low-Cost LiOH.H₂O Production
- 06 May 2021 - EIA SUBMITTED MEASURED RESOURCE DRILLING UPDATE
- 19 May 2021 - STRONG RESULTS FROM LOCKED CYCLE TESTS CONFIRMS PROCESS
- 27 May 2021 - Replacement addendum to ASX Release 19 May 2021
- 13 Oct 2021 - Resource Upgrade at Cinovec Lithium Project.

Note that these announcements are not the only announcements released to the ASX or published via RNS in the UK but are specific to exploration reporting on the Cinovec Project. The Company confirms that it is not aware of any new information or data that materially affects the published information in respect of the Project.

BACKGROUND INFORMATION ON CINOVEC

Cinovec Lithium/Tin Project

Geomet s.r.o. controls the mineral exploration licenses awarded by the Czech State over the Cinovec Lithium/Tin Project. Geomet has been granted a preliminary mining permit by the Ministry of Environment and the Ministry of Industry. The company is owned 49% by EMH and 51% by CEZ a.s. through its wholly owned subsidiary, SDAS. Cinovec hosts a globally significant hard rock lithium deposit with a total Measured Mineral Resource of 53.3Mt at 0.47% Li₂O and 0.08% Sn, Indicated Mineral Resource of 361.9Mt at 0.45% Li₂O and 0.04% Sn and an Inferred Mineral Resource of 295Mt at 0.39% Li₂O and 0.04% Sn containing a combined 7.39 million tonnes Lithium Carbonate Equivalent and 263kt of tin (refer to the Company's ASX release dated 13 October 2021) (**Resource Upgrade at Cinovec Lithium Project**).

An initial Probable Ore Reserve of 34.5Mt at 0.65% Li₂O and 0.09% Sn reported 4 July 2017 (**Cinovec Maiden Ore Reserve – Further Information**) has been declared to cover the first 20 years mining at an

output of 22,500tpa of lithium carbonate (refer to the Company's ASX release dated 11 July 2018) (**Cinovec Production Modelled to Increase to 22,500tpa of Lithium Carbonate**).

This makes Cinovec the largest hard rock lithium deposit in Europe, the fourth largest non-brine deposit in the world and a globally significant tin resource.

The deposit has previously had over 400,000 tonnes of ore mined as a trial sub-level open stope underground mining operation.

In this ASX Release, EMH provides an update to the 2019 PFS Update, conducted by specialist independent consultants, which indicates a return post tax NPV of USD1.938B and a post tax IRR of 36.3% and confirmed that the Cinovec Project is a potential low operating cost, producer of battery grade lithium hydroxide or battery grade lithium carbonate as markets demand. It confirmed the deposit is amenable to bulk underground mining. Metallurgical test-work has produced both battery grade lithium hydroxide and battery grade lithium carbonate in addition to high-grade tin concentrate at excellent recoveries. Cinovec is centrally located for European end-users and is well serviced by infrastructure, with a sealed road adjacent to the deposit, rail lines located 5 km north and 8 km south of the deposit and an active 22 kV transmission line running to the historic mine. As the deposit lies in an active mining region, it has strong community support.

The economic viability of Cinovec has been enhanced by the recent strong increase in demand for lithium globally, and within Europe specifically.

There are no other material changes to the original information and all the material assumptions continue to apply to the forecasts.

CONTACT

For further information on this update or the Company generally, please visit our website at www.europeanmet.com or see full contact details at the end of this release.

ENQUIRIES:

European Metals Holdings Limited

Keith Coughlan, Executive Chairman

Tel: +61 (0) 419 996 333

Email: keith@europeanmet.com

Kiran Morzaria, Non-Executive Director

Tel: +44 (0) 20 7440 0647

Dennis Wilkins, Company Secretary

Tel: +61 (0) 417 945 049

Email: dennis@europeanmet.com

WH Ireland Ltd (Nomad & Joint Broker)

James Joyce/ Darshan Patel
(Corporate Finance)

Harry Ansell/Jasper Berry (Broking)

Tel: +44 (0) 20 7220 1666

Shard Capital (Joint Broker)

Damon Heath
Erik Woolgar

Tel: +44 (0) 20 7186 9950

Blytheweigh (Financial PR)

Tim Blythe
Megan Ray

Tel: +44 (0) 20 7138 3222

Chapter 1 Advisors (Financial PR – Aus)

David Tasker

Tel: +61 (0) 433 112 936

The information contained within this announcement is considered to be inside information, for the purposes of Article 7 of EU Regulation 596/2014, prior to its release. The person who authorised for the release of this announcement on behalf of the Company was Keith Coughlan, Executive Chairman.

CAUTION REGARDING FORWARD LOOKING STATEMENTS

Information included in this release constitutes forward-looking statements. Often, but not always, forward looking statements can generally be identified by the use of forward looking words such as "may", "will", "expect", "intend", "plan", "estimate", "anticipate", "continue", and "guidance", or other similar words and may include, without limitation, statements regarding plans, strategies and objectives of management, anticipated production or construction commencement dates and expected costs or production outputs.

Forward looking statements inherently involve known and unknown risks, uncertainties and other factors that may cause the company's actual results, performance and achievements to differ materially from any future results, performance or achievements. Relevant factors may include, but are not limited to, changes in commodity prices, foreign exchange fluctuations and general economic conditions, increased costs and demand for production inputs, the speculative nature of exploration and project development, including the risks of obtaining necessary licences and permits and diminishing quantities or grades of reserves, political and social risks, changes to the regulatory framework within which the company operates or may in the future operate, environmental conditions including extreme weather conditions, recruitment and retention of personnel, industrial relations issues and litigation.

Forward looking statements are based on the company and its management's good faith assumptions relating to the financial, market, regulatory and other relevant environments that will exist and affect the company's business and operations in the future. The company does not give any assurance that the assumptions on which forward looking statements are based will prove to be correct, or that the company's business or operations will not be affected in any material manner by these or other factors not foreseen or foreseeable by the company or management or beyond the company's control.

Although the Company attempts and has attempted to identify factors that would cause actual actions, events or results to differ materially from those disclosed in forward looking statements, there may be other factors that could cause actual results, performance, achievements or events not to be as anticipated, estimated or intended, and many events are beyond the reasonable control of the company. Accordingly, readers are cautioned not to place undue reliance on forward looking statements. Forward looking statements in these materials speak only at the date of issue. Subject to any continuing obligations under applicable law or any relevant stock exchange listing rules, in providing this information the company does not undertake any obligation to publicly update or revise any of the forward looking statements or to advise of any change in events, conditions or circumstances on which any such statement is based.

This announcement has been prepared in compliance with the JORC Code 2012 Edition and the current ASX Listing Rules.

The Company believes that it has a reasonable basis for making the forward-looking statements in this announcement, including with respect to any mining of mineralised material, modifying factors and production targets and financial forecasts.

The following information is specifically provided in support of this belief:

- (1) The 2017 PFS was completed by independent specialist firms with oversight provided by the Company's Owner's Team under the direction of Andrew Smith (B.Eng., B.Com from University of Sydney). The 2019 PFS Update was completed under the direction of Neil Meadows (M.App.Sc. (Metallurgy) South Aust. Inst. Tech.).
- (2) The 2019 PFS Update was prepared to an overall level of accuracy of approximately $\pm 25\%$ for capital and operating costs.
- (3) The 2022 PFS Update described here presents an initial appraisal of the use of backfill on the project.
- (4) Production targets and financial forecasts disclosed in this announcement are based exclusively on Measured and Indicated Resource categories as defined under the JORC Code 2012.
- (5) The 2017 PFS and 2019 PFS Update metallurgical test-work programme was developed and supervised by industry leaders in Western Australia and Germany and was performed by specialist laboratories in the areas of expertise that included Dorfner Anzaplan, Nagrom and ALS.
- (6) Mr Grant Harman (B.Sc Chem Eng, B.Com) is an independent consultant with in excess of 7 years of lithium chemicals experience. Mr Harman supervised and reviewed the metallurgical test work and the process design criteria and flow sheets in relation to the LCP.
- (7) The independent consultants to the 2017 PFS and 2019 PFS Update prepared the process design criteria and flowsheet based on metallurgical test work and typical industry design parameters.
- (8) The mine planning and scheduling for the revised 2.25Mtpa base case in this 2022 PFS Update was undertaken by independent mining firm Bara Consulting.
- (9) Mining operating costs were based on estimates derived from equipment and mechanical quotes, first principle manpower build-ups and an extensive industry database in the 2017 PFS. Mining operating costs including backfill have been updated using factorised estimates in this 2022 PFS Update.
- (10) Processing operating costs assessed in the 2019 PFS Update are re-estimated in this 2022 PFS Update. The information in this announcement that relates to Process Plant capital and operating cost estimates is based on reports compiled by the independent consultants.
- (11) Capital cost estimates for backfill and related infrastructure in this 2022 PFS Update are based on factorised estimates from previous studies unrelated to the Cinovec Project. Updated capital costs for mining and process plant in this 2022 PFS Update have been factorised from the relevant costs in the 2019 PFS Update.
- (12) Mining related geotechnical engineering was undertaken by independent mining firm Bara Consulting and included extensive geotechnical logging and laboratory testing.
- (13) The Project will potentially be the first large-scale hard rock mine to be developed in the Czech Republic in many decades. As such, stakeholder engagement with the Government of the Czech Republic, both locally and regionally and in particular with the Ministry of Industry has been on going. We therefore anticipate that given the potential size, scale and significance of the Project to the Czech Republic and the potential downstream use of the lithium product and

For personal use only

assuming any development complies with all relevant mining and environmental legislation, all necessary approval processes will be able to be secured for the Project.

- (14) The Company has engaged a specialist environmental consulting firm in the Czech Republic, GET s.r.o Ltd, to advise it on all aspects of the EIA process. This includes all environmental baseline studies.
- (15) The Company's Board and management have had a very successful track record of developing and financing mineral resource development globally. The Company is confident there is a good possibility that it will continue to increase the Mineral Resources at the Project through exploration. Furthermore, the Company has recently upgraded the Mineral Resource estimate to include 53.3MT into the Measured category. The Company is confident that this exploration, combined with the use of only 7.7% of the total Mineral Resource estimate in this 2022 PFS Update, will extend the mine life greatly from that which is currently modelled.
- (16) The Project's positive technical and economic fundamentals provide a platform for the Company to advance discussions with traditional debt and equity financiers and forward sales arrangements. The size and location of the deposit in the middle of large end users associated with European electric vehicles that is driving lithium demand will make the project a strategic asset as evidenced by the large interest shown in the Project by end users and large lithium specialist companies to-date. An improvement in market conditions since work commenced and a perceived high growth outlook for the global lithium market enhance the Company's view of the fundability of the Project. Based on this, the Board is confident the Company will be able to finance the Project through a combination of debt and equity, or forward sales. In addition, the Company's aim will be to avoid dilution to existing shareholders, to the greatest extent possible.
- (17) This 2022 PFS Update is based on the assumption that all metal produced will be sold via long term contracts to end users. It is assumed the lithium carbonate and/or lithium hydroxide will be sold electric vehicle end users in both the Czech Republic and surrounding countries and that tin and tungsten concentrates will be sold to Asian smelters for further processing.
- (18) Board and Management has been responsible for the study, financing and/or development of several large and diverse mining and exploration projects globally. Based on this experience, and on professional advice received, the board believes that a traditional debt:equity ratio of 70:30 is potentially achievable for the Project based on the PFS results.

For the reasons outlined above, the Board believes that there is a "reasonable basis" to assume that future funding will be available and securable.

All material assumptions on which the production target and forecast financial information derived from the production target are based have been included in this announcement.

Key Risks

Key risks identified during the study include:

- Adverse movements in lithium pricing;
- Adverse movements in key operating cost inputs;
- Timely project approvals by the authorities;
- Conversion of existing Resources to Reserves;
- Results of future feasibility studies are uncertain; and
- Project funding.

For personal use only

LITHIUM CLASSIFICATION AND CONVERSION FACTORS

Lithium grades are normally presented in percentages or parts per million (ppm). Grades of deposits are also expressed as lithium compounds in percentages, for example as a percent lithium oxide (Li₂O) content or percent lithium carbonate (Li₂CO₃) content.

Lithium carbonate equivalent (“LCE”) is the industry standard terminology for, and is equivalent to, Li₂CO₃. Use of LCE is to provide data comparable with industry reports and is the total equivalent amount of lithium carbonate, assuming the lithium content in the deposit is converted to lithium carbonate, using the conversion rates in the table included below to get an equivalent Li₂CO₃ value in percent. Use of LCE assumes 100% recovery and no process losses in the extraction of Li₂CO₃ from the deposit.

Lithium resources and reserves are usually presented in tonnes of LCE or Li.

The standard conversion factors are set out in the table below:

Table 12: Conversion Factors for Lithium Compounds and Minerals

Convert from		Convert to Li	Convert to Li ₂ O	Convert to Li ₂ CO ₃
Lithium	Li	1.000	2.153	5.325
Lithium Oxide	Li ₂ O	0.464	1.000	2.473
Lithium Carbonate	Li ₂ CO ₃	0.188	0.404	1.000
Lithium Hydroxide	LiOH.H ₂ O	0.165	0.356	0.880

WEBSITE

A copy of this announcement is available from the Company’s website at www.europeanmet.com.

TECHNICAL GLOSSARY

The following is a summary of technical terms:

“ball and rod indices”	Indices that provide an assessment of the energy required to grind one tonne of material in a ball or rod mill
“carbonate”	refers to a carbonate mineral such as calcite, CaCO ₃
“comminution”	The crushing and/or grinding of material to a smaller scale
“cut-off grade”	lowest grade of mineralised material considered economic, used in the calculation of Mineral Resources
“deposit”	coherent geological body such as a mineralised body
“exploration”	method by which ore deposits are evaluated
“flotation”	selectively separating hydrophobic materials from hydrophilic materials to upgrade the concentration of valuable minerals
“g/t”	gram per metric tonne
“grade”	relative quantity or the percentage of ore mineral or metal content in an ore body
“heavy liquid separation”	is based on the fact that different minerals have different densities. Thus, if a mixture of minerals with different densities can be placed in a liquid with an intermediate density, the grains with densities less than that of the liquid will float and grains with densities greater than the liquid will sink

For personal use only

“Indicated” or “Indicated Mineral Resource”

as defined in the JORC and SAMREC Codes, is that part of a Mineral Resource which has been sampled by drill holes, underground openings or other sampling procedures at locations that are too widely spaced to ensure continuity but close enough to give a reasonable indication of continuity and where geoscientific data are known with a reasonable degree of reliability. An Indicated Mineral Resource will be based on more data and therefore will be more reliable than an Inferred Mineral Resource estimate

“Inferred” or “Inferred Mineral Resource”

as defined in the JORC and SAMREC Codes, is that part of a Mineral Resource for which the tonnage and grade and mineral content can be estimated with a low level of confidence. It is inferred from the geological evidence and has assumed but not verified geological and/or grade continuity. It is based on information gathered through the appropriate techniques from locations such as outcrops, trenches, pits, working and drill holes which may be limited or of uncertain quality and reliability

“JORC Code”

Joint Ore Reserve Committee Code; the Committee is convened under the auspices of the Australasian Institute of Mining and Metallurgy

“kt”

thousand tonnes

“LCE”

the total equivalent amount of lithium carbonate (see explanation above entitled Explanation of Lithium Classification and Conversion Factors)

“LiOH”

lithium hydroxide monohydrate (LiOH.H₂O), the commercial form of lithium hydroxide

“lithium”

a soft, silvery-white metallic element of the alkali group, the lightest of all metals

“lithium carbonate”

the lithium salt of carbonate with the formula Li₂CO₃

“magnetic separation”

is a process in which magnetically susceptible material is extracted from a mixture using a magnetic force

“metallurgical”

describing the science concerned with the production, purification and properties of metals and their applications

“Mineral Resource”

a concentration or occurrence of material of intrinsic economic interest in or on the Earth’s crust in such a form that there are reasonable prospects for the eventual economic extraction; the location, quantity, grade geological characteristics and continuity of a mineral resource are known, estimated or interpreted from specific geological evidence and knowledge; mineral resources are sub-divided into Inferred, Indicated and Measured categories

“mineralisation”

process of formation and concentration of elements and their chemical compounds within a mass or body of rock

“Mt”

million tonnes

“optical microscopy”

the determination of minerals by observation through an optical microscope

“ppm”

parts per million

“recovery”

proportion of valuable material obtained in the processing of an ore, stated as a percentage of the material recovered compared with the total material present

“SAGability”

testing material to investigate its performance in a semi-autonomous grinding mill

“spiral concentration”

a process that utilises the differential density of materials to concentrate valuable minerals

“stope”

underground excavation within the orebody where the main production takes place

“t”

a metric tonne

For personal use only

“tin”	A tetragonal mineral, rare; soft; malleable: bluish white, found chiefly in cassiterite, SnO ₂
“treatment”	Physical or chemical treatment to extract the valuable metals/minerals
“tungsten”	hard, brittle, white or grey metallic element. Chemical symbol, W; also known as wolfram
“W”	chemical symbol for tungsten

ADDITIONAL GEOLOGICAL TERMS

“apical”	relating to, or denoting an apex
“cassiterite”	A mineral, tin dioxide, SnO ₂ . Ore of tin with specific gravity 7
“cupola”	A dome-shaped projection at the top of an igneous intrusion
“dip”	the true dip of a plane is the angle it makes with the horizontal plane
“granite”	coarse-grained intrusive igneous rock dominated by light-coloured minerals, consisting of about 50% orthoclase, 25% quartz and balance of plagioclase feldspars and ferromagnesian silicates
“greisen”	A pneumatolitically altered granitic rock composed largely of quartz, mica, and topaz. The mica is usually muscovite or lepidolite. Tourmaline, fluorite, rutile, cassiterite, and wolframite are common accessory minerals
“igneous”	said of a rock or mineral that solidified from molten or partly molten material, i.e., from a magma
“muscovite”	also known as potash mica; formula: KAl ₂ (AlSi ₃ O ₁₀)(F,OH) ₂ .
“quartz”	a mineral composed of silicon dioxide, SiO ₂
“rhyolite”	An igneous, volcanic rock of felsic (silica rich) composition. Typically >69% SiO ₂
“vein”	a tabular deposit of minerals occupying a fracture, in which particles may grow away from the walls towards the middle
“wolframite”	A mineral, (Fe,Mn)WO ₄ ; within the huebnerite-ferberite series
“zinnwaldite”	A mineral, KLiFeAl(AlSi ₃)O ₁₀ (F,OH) ₂ ; mica group; basal cleavage; pale violet, yellowish or greyish brown; in granites, pegmatites, and greisens

PREVIOUSLY REPORTED INFORMATION

The information in this report relating to Exploration Results, Mineral Resources, Ore Reserves, production targets and forecast financial information derived from a production target (other than the information being updated in this report) is extracted from the Company's ASX releases referred to in the body of the report and are available to view on the Company's ASX announcements platform (ASX: EMH). The Company confirms that it is not aware of any new information or data that materially affects the information included in the original market announcements and, in the case of estimates of Mineral Resources or Ore Reserves, that all material assumptions and technical parameters underpinning the estimates in the relevant market announcement continue to apply and have not materially changed. The Company confirms that the form and context in which the Competent Person's findings are presented have not been materially modified from the original market announcement.

For personal use only

European Metals Ltd – Cinovec Deposit – January 2022

JORC Code, 2012 Edition – Table 1

Section 1 Sampling Techniques and Data

Criteria	JORC Code explanation	Commentary
Sampling techniques	<ul style="list-style-type: none"> Nature and quality of sampling (eg cut channels, random chips, or specific specialised industry standard measurement tools appropriate to the minerals under investigation, such as down hole gamma sondes, or handheld XRF instruments, etc). These examples should not be taken as limiting the broad meaning of sampling. Include reference to measures taken to ensure sample representivity and the appropriate calibration of any measurement tools or systems used. Aspects of the determination of mineralisation that are Material to the Public Report. In cases where 'industry standard' work has been done this would be relatively simple (eg 'reverse circulation drilling was used to obtain 1 m samples from which 3 kg was pulverised to produce a 30 g charge for fire assay'). In other cases more explanation may be required, such as where there is coarse gold that has inherent sampling problems. Unusual commodities or mineralisation types (eg submarine nodules) may warrant disclosure of detailed information. 	<ul style="list-style-type: none"> Between 2014 and 2021, the Company commenced a core drilling program and collected samples from core splits in line with JORC Code guidelines. Sample intervals honour geological or visible mineralisation boundaries and vary between 50cm and 2m. The majority of samples are 1m in length. The samples are half or quarter of core; the latter applied for large diameter core. Between 1952 and 1989, the Cinovec deposit was sampled in two ways: in drill core and underground channel samples. Channel samples, from drift ribs and faces, were collected during detailed exploration between 1952 and 1989 by Geindustria n.p. and Rudne Doly n.p., both Czechoslovak State companies. Sample length was 1m, channel 10x5cm, sample mass about 15kg. Up to 1966, samples were collected using hammer and chisel; from 1966 a small drill (Holman Hammer) was used. 14179 samples were collected and transported to a crushing facility. Core and channel samples were crushed in two steps: to -5mm, then to -0.5mm. 100g splits were obtained and pulverized to -0.045mm for analysis.
Drilling techniques	<ul style="list-style-type: none"> Drill type (eg core, reverse circulation, open-hole hammer, rotary air blast, auger, Bangka, sonic, etc) and details (eg core diameter, triple or standard tube, depth of diamond tails, face-sampling bit or other type, whether core is oriented and if so, by what method, etc). 	<ul style="list-style-type: none"> In 2014, three core holes were drilled for a total of 940.1m. In 2015, six core holes were drilled for a total of 2,455.0m. In 2016, eighteen core holes were drilled for a total of 6,459.6m. In 2017, six core holes were drilled for a total of 2697.1m. In 2018, 5 core holes were drilled for a total of 1,640.3 and in 2020, 22 core holes were drilled for a total of 6,621.7m. In 2014 and 2015, the core size was HQ3 (60mm diameter) in upper parts of holes; in deeper sections the core size was reduced to NQ3 (44mm diameter). Core recovery was high (average 98%). Between 2016 and 2021 up to four drill rigs were used, and select holes employed PQ sized core for upper parts of the drillholes. Historically only core drilling was employed, either from surface or from underground.

For personal use only

Criteria	JORC Code explanation	Commentary
		<ul style="list-style-type: none"> • Surface drilling: 149 holes, total 55,570 meters; vertical and inclined, maximum depth 1596m (structural hole). Core diameters from 220mm near surface to 110 mm at depth. Average core recovery 89.3%. • Underground drilling: 766 holes for 53,126m; horizontal and inclined. Core diameter 46mm; drilled by Craelius XC42 or DIAMEC drills.
Drill sample recovery	<ul style="list-style-type: none"> • Method of recording and assessing core and chip sample recoveries and results assessed. • Measures taken to maximise sample recovery and ensure representative nature of the samples. • Whether a relationship exists between sample recovery and grade and whether sample bias may have occurred due to preferential loss/gain of fine/coarse material. 	<ul style="list-style-type: none"> • Core recovery for historical surface drill holes was recorded on drill logs and entered into the database. • No correlation between grade and core recovery was established.
Logging	<ul style="list-style-type: none"> • Whether core and chip samples have been geologically and geotechnically logged to a level of detail to support appropriate Mineral Resource estimation, mining studies and metallurgical studies. • Whether logging is qualitative or quantitative in nature. Core (or costean, channel, etc) photography. • The total length and percentage of the relevant intersections logged. 	<ul style="list-style-type: none"> • In 2014-2021, core descriptions were recorded into paper logging forms by hand and later entered into an Excel database. • Core was logged in detail historically in a facility 6km from the mine site. The following features were logged and recorded in paper logs: lithology, alteration (including intensity divided into weak, medium and strong/pervasive), and occurrence of ore minerals expressed in %, macroscopic description of congruous intervals and structures and core recovery.
Sub-sampling techniques and sample preparation	<ul style="list-style-type: none"> • If core, whether cut or sawn and whether quarter, half or all core taken. • If non-core, whether riffled, tube sampled, rotary split, etc and whether sampled wet or dry. • For all sample types, the nature, quality and appropriateness of the sample preparation technique. • Quality control procedures adopted for all sub-sampling stages to maximise representivity of samples. • Measures taken to ensure that the sampling is representative of the in situ material collected, including for instance results for field duplicate/second-half sampling. • Whether sample sizes are appropriate to the grain size of the material being sampled. 	<ul style="list-style-type: none"> • In 2014-21, core was washed, geologically logged, sample intervals determined and marked then the core was cut in half. Larger core was cut in half and one half was cut again to obtain a quarter core sample. One half or one quarter samples was delivered to ALS Global for assaying after duplicates, blanks and standards were inserted in the sample stream. The remaining drill core is stored on site for reference. • Sample preparation was carried out by ALS Global in Romania, using industry standard techniques appropriate for the style of mineralisation represented at Cinovec. • Historically, core was either split or consumed entirely for analyses. • Samples are considered to be representative. • Sample sizes relative to grain sizes are deemed appropriate for the analytical

For personal use only

Criteria	JORC Code explanation	Commentary
		techniques used.
Quality of assay data and laboratory tests	<ul style="list-style-type: none"> The nature, quality and appropriateness of the assaying and laboratory procedures used and whether the technique is considered partial or total. For geophysical tools, spectrometers, handheld XRF instruments, etc, the parameters used in determining the analysis including instrument make and model, reading times, calibrations factors applied and their derivation, etc. Nature of quality control procedures adopted (eg standards, blanks, duplicates, external laboratory checks) and whether acceptable levels of accuracy (ie lack of bias) and precision have been established. 	<ul style="list-style-type: none"> In 2014-21, core samples were assayed by ALS Global. The most appropriate analytical methods were determined by results of tests for various analytical techniques. The following analytical methods were chosen: ME-MS81 (lithium borate fusion or 4 acid digest, ICP-MS finish) for a suite of elements including Sn and W and ME-4ACD81 (4 acid digest, ICP-AES finish) additional elements including lithium. About 40% of samples were analysed by ME-MS81d (ME-MS81 plus whole rock package). Samples with over 1% tin are analysed by XRF. Samples over 1% lithium were analysed by Li-OG63 (four acid and ICP finish). Standards, blanks and duplicates were inserted into the sample stream. Initial tin standard results indicated possible downgrading bias; the laboratory repeated the analysis with satisfactory results. Historically, Sn content was measured by XRF and using wet chemical methods. W and Li were analysed by spectral methods. Analytical QA was internal and external. The former subjected 5% of the sample to repeat analysis in the same facility. 10% of samples were analysed in another laboratory, also located in Czechoslovakia. The QA/QC procedures were set to the State norms and are considered adequate. It is unknown whether external standards or sample duplicates were used. Overall accuracy of sampling and assaying was proved later by test mining and reconciliation of mined and analysed grades.
Verification of sampling and assaying	<ul style="list-style-type: none"> The verification of significant intersections by either independent or alternative company personnel. The use of twinned holes. Documentation of primary data, data entry procedures, data verification, data storage (physical and electronic) protocols. Discuss any adjustment to assay data. 	<ul style="list-style-type: none"> During the 2014-21 drill campaigns Geomet indirectly verified grades of tin and lithium by comparing the length and grade of mineral intercepts with the current block model.
Location of data points	<ul style="list-style-type: none"> Accuracy and quality of surveys used to locate drill holes (collar and down-hole surveys), trenches, mine workings and other locations used in Mineral Resource 	<ul style="list-style-type: none"> In 2014-21, drill collar locations were surveyed by a registered surveyor. Down hole surveys were recorded by a contractor.

For personal use only

Criteria	JORC Code explanation	Commentary
	<p>estimation.</p> <ul style="list-style-type: none"> • Specification of the grid system used. • Quality and adequacy of topographic control. 	<ul style="list-style-type: none"> • Historically, drill hole collars were surveyed with a great degree of precision by the mine survey crew. • Hole locations are recorded in the local S-JTSK Krovak grid. • Topographic control is excellent.
Data spacing and distribution	<ul style="list-style-type: none"> • Data spacing for reporting of Exploration Results. • Whether the data spacing and distribution is sufficient to establish the degree of geological and grade continuity appropriate for the Mineral Resource and Ore Reserve estimation procedure(s) and classifications applied. • Whether sample compositing has been applied. 	<ul style="list-style-type: none"> • Historical data density is very high. • Spacing is sufficient to establish Measured, Indicated and Inferred Mineral Resource Estimates. • Areas with lower coverage of Li% assays have been identified as Exploration Targets. • Sample compositing to 1m intervals has been applied mathematically prior to estimation but not physically.
Orientation of data in relation to geological structure	<ul style="list-style-type: none"> • Whether the orientation of sampling achieves unbiased sampling of possible structures and the extent to which this is known, considering the deposit type. • If the relationship between the drilling orientation and the orientation of key mineralised structures is considered to have introduced a sampling bias, this should be assessed and reported if material. 	<ul style="list-style-type: none"> • In 2014-21, drill hole azimuth and dip was planned to intercept the mineralized zones at near-true thickness. As the mineralized zones dip shallowly to the south, drill holes were vertical or near vertical and directed to the north. Due to land access restrictions, certain holes could not be positioned in sites with ideal drill angle. • Geomet has not directly collected any samples underground because the workings are inaccessible at this time. • Based on historic reports, level plan maps, sections and core logs, the samples were collected in an unbiased fashion, systematically on two underground levels from drift ribs and faces, as well as from underground holes drilled perpendicular to the drift directions. The sample density is adequate for the style of deposit. • Multiple samples were taken and analysed by the Company from the historic tailing repository. Only lithium was analysed (Sn and W too low). The results matched the historic grades.
Sample security	<ul style="list-style-type: none"> • The measures taken to ensure sample security. 	<ul style="list-style-type: none"> • In the 2014-21 programs, only Geomet's employees and contractors handled drill core and conducted sampling. The core was collected from the drill rig each day and transported in a company vehicle to the secure Geomet premises where it was logged and cut. Geomet geologists supervised the process and logged/sampled the core. The samples were transported by Geomet personnel in a company vehicle to the ALS Global laboratory pick-up station. The remaining core is stored under lock and key. • Historically, sample security was ensured by State norms applied to exploration.

For personal use only

Criteria	JORC Code explanation	Commentary
		The State norms were similar to currently accepted best practice and JORC guidelines for sample security.
Audits or reviews	<ul style="list-style-type: none"> The results of any audits or reviews of sampling techniques and data. 	<ul style="list-style-type: none"> Review of sampling techniques was carried out from written records. No flaws found.

Section 2 Reporting of Exploration Results

(Criteria listed in section 1 also apply to this section.)

Criteria	JORC Code explanation	Commentary
Mineral tenement and land tenure status	<ul style="list-style-type: none"> Type, reference name/number, location and ownership including agreements or material issues with third parties such as joint ventures, partnerships, overriding royalties, native title interests, historical sites, wilderness or national park and environmental settings. The security of the tenure held at the time of reporting along with any known impediments to obtaining a licence to operate in the area. 	<ul style="list-style-type: none"> In June 2020, the Czech Ministry of the Environment granted Geomet three Preliminary Mining Permits which cover the whole of the Cinovec deposit. The permits are valid until 2028. Geomet plans to amalgamate these into a single Final Mining Permit.
Exploration done by other parties	<ul style="list-style-type: none"> Acknowledgment and appraisal of exploration by other parties. 	<ul style="list-style-type: none"> There has been no acknowledgment or appraisal of exploration by other parties.
Geology	<ul style="list-style-type: none"> Deposit type, geological setting and style of mineralisation. 	<ul style="list-style-type: none"> Cinovec is a granite-hosted tin-tungsten-lithium deposit. Late Variscan age, post-orogenic granite intrusion tin and tungsten occur in oxide minerals (cassiterite and wolframite). Lithium occurs in zinnwaldite, a Li-rich muscovite. Mineralization in a small granite cupola. Vein and greisen type. Alteration is greisenisation, silicification.
Drill hole Information	<ul style="list-style-type: none"> A summary of all information material to the understanding of the exploration results including a tabulation of the following information for all Material drill holes: <ul style="list-style-type: none"> easting and northing of the drill hole collar elevation or RL (Reduced Level – elevation above sea level in metres) of the drill hole collar dip and azimuth of the hole down hole length and interception depth hole length. 	<ul style="list-style-type: none"> Reported previously.

Criteria	JORC Code explanation	Commentary
	<ul style="list-style-type: none"> If the exclusion of this information is justified on the basis that the information is not Material and this exclusion does not detract from the understanding of the report, the Competent Person should clearly explain why this is the case. 	
Data aggregation methods	<ul style="list-style-type: none"> In reporting Exploration Results, weighting averaging techniques, maximum and/or minimum grade truncations (eg cutting of high grades) and cut-off grades are usually Material and should be stated. Where aggregate intercepts incorporate short lengths of high grade results and longer lengths of low grade results, the procedure used for such aggregation should be stated and some typical examples of such aggregations should be shown in detail. The assumptions used for any reporting of metal equivalent values should be clearly stated. 	<ul style="list-style-type: none"> Reporting of exploration results has not and will not include aggregate intercepts. Metal equivalent not used in reporting. No grade truncations applied.
Relationship between mineralisation widths and intercept lengths	<ul style="list-style-type: none"> These relationships are particularly important in the reporting of Exploration Results. If the geometry of the mineralisation with respect to the drill hole angle is known, its nature should be reported. If it is not known and only the down hole lengths are reported, there should be a clear statement to this effect (eg 'down hole length, true width not known'). 	<ul style="list-style-type: none"> Intercept widths are approximate true widths. The mineralization is mostly of disseminated nature and relatively homogeneous; the orientation of samples is of limited impact. For higher grade veins care was taken to drill at angles ensuring closeness of intercept length and true widths. The block model accounts for variations between apparent and true dip.
Diagrams	<ul style="list-style-type: none"> Appropriate maps and sections (with scales) and tabulations of intercepts should be included for any significant discovery being reported These should include, but not be limited to a plan view of drill hole collar locations and appropriate sectional views. 	<ul style="list-style-type: none"> Appropriate maps and sections have been generated by Geomet and independent consultants. Available in customary vector and raster outputs and partially in consultant's reports.
Balanced reporting	<ul style="list-style-type: none"> Where comprehensive reporting of all Exploration Results is not practicable, representative reporting of both low and high grades and/or widths should be 	<ul style="list-style-type: none"> Balanced reporting in historic reports guaranteed by norms and standards, verified in 1997 and 2012 by independent consultants. The historic reporting was completed

Criteria	JORC Code explanation	Commentary
	<i>practiced to avoid misleading reporting of Exploration Results.</i>	by several State institutions and cross validated.
<i>Other substantive exploration data</i>	<ul style="list-style-type: none"> <i>Other exploration data, if meaningful and material, should be reported including (but not limited to): geological observations; geophysical survey results; geochemical survey results; bulk samples – size and method of treatment; metallurgical test results; bulk density, groundwater, geotechnical and rock characteristics; potential deleterious or contaminating substances.</i> 	<ul style="list-style-type: none"> Data available: bulk density for all representative rock and ore types; (historic data + 92 measurements in 2016-21 from current core holes); petrographic and mineralogical studies, hydrological information, hardness, moisture content, fragmentation etc.
<i>Further work</i>	<ul style="list-style-type: none"> <i>The nature and scale of planned further work (eg tests for lateral extensions or depth extensions or large-scale step-out drilling).</i> <i>Diagrams clearly highlighting the areas of possible extensions, including the main geological interpretations and future drilling areas, provided this information is not commercially sensitive.</i> 	<ul style="list-style-type: none"> Grade verification sampling from underground or drilling from surface. Historically-reported grades require modern validation in order to improve the resource classification. The number and location of sampling sites will be determined from a 3D wireframe model and geostatistical considerations reflecting grade continuity. The geologic model will be used to determine if any infill drilling is required. The deposit is open down-dip on the southern extension, and locally poorly constrained at its western and eastern extensions, where limited additional drilling might be required. No large-scale drilling campaigns are required.

Section 3 Estimation and Reporting of Mineral Resources

(Criteria listed in section 1, and where relevant in section 2, also apply to this section.)

Criteria	JORC Code explanation	Commentary
<i>Database integrity</i>	<ul style="list-style-type: none"> <i>Measures taken to ensure that data has not been corrupted by, for example, transcription or keying errors, between its initial collection and its use for Mineral Resource estimation purposes.</i> <i>Data validation procedures used.</i> 	<ul style="list-style-type: none"> Assay and geologic data were compiled by Geomet staff from primary historic records, such as copies of drill logs and large scale sample location maps. Sample data were entered in to Excel spreadsheets by Geomet staff. The database entry process was supervised by a Professional Geologist who works for Geomet. The database was checked by independent competent persons (Lynn Widenbar of Widenbar &

For personal use only

Criteria	JORC Code explanation	Commentary
Site visits	<ul style="list-style-type: none"> • <i>Comment on any site visits undertaken by the Competent Person and the outcome of those visits.</i> • <i>If no site visits have been undertaken indicate why this is the case.</i> 	<p>Associates).</p> <ul style="list-style-type: none"> • The site was visited by Dr Pavel Reichl who identified the previous shaft sites, tails dams and observed the mineralisation underground through an adjacent mine working and was previously the Competent Person for exploration results. • The current Competent Person for exploration results, Dr Vojtech Sesulka, has visited the site on multiple occasions and has been involved in 2014 to 2021 drilling campaigns. • The site was visited in June 2016 by Mr Lynn Widenbar, the Competent Person for Mineral Resource Estimation. Diamond drill rigs were viewed, as was core; a visit was carried out to the adjacent underground mine in Germany which is a continuation of the Cinovec Deposit.
Geological interpretation	<ul style="list-style-type: none"> • <i>Confidence in (or conversely, the uncertainty of) the geological interpretation of the mineral deposit.</i> • <i>Nature of the data used and of any assumptions made.</i> • <i>The effect, if any, of alternative interpretations on Mineral Resource estimation.</i> • <i>The use of geology in guiding and controlling Mineral Resource estimation.</i> • <i>The factors affecting continuity both of grade and geology.</i> 	<ul style="list-style-type: none"> • The overall geology of the deposit is relatively simple and well understood due to excellent data control from surface and underground. • Nature of data: underground mapping, structural measurements, detailed core logging, 3D data synthesis on plans and maps. • Geological continuity is good. The grade is highest and shows most variability in quartz veins. • Grade correlates with degree of silicification and greisenisation of the host granite. • The primary control is the granite-country rock contact. All mineralization is in the uppermost 200m of the granite and is truncated by the contact.
Dimensions	<ul style="list-style-type: none"> • <i>The extent and variability of the Mineral Resource expressed as length (along strike or otherwise), plan width, and depth below surface to the upper and lower limits of the Mineral Resource.</i> 	<ul style="list-style-type: none"> • The Cinovec Deposit strikes north-south, is elongated, and dips gently south parallel to the upper granite contact. The surface projection of mineralization is about 1km long and 900m wide. • Mineralization extends from about 200m to 500m below surface.
Estimation and modelling techniques	<ul style="list-style-type: none"> • <i>The nature and appropriateness of the estimation technique(s) applied and key assumptions, including treatment of extreme grade values, domaining, interpolation parameters and maximum distance of extrapolation from data</i> 	<ul style="list-style-type: none"> • Block estimation was carried out in Micromine 2021.5 using Ordinary Kriging interpolation. • A geological domain model was constructed using Leapfrog software with solid wireframes representing greisen, granite, greisenised granite

For personal use only

For personal use only

Criteria	JORC Code explanation	Commentary
	<p><i>points. If a computer assisted estimation method was chosen include a description of computer software and parameters used.</i></p> <ul style="list-style-type: none"> • <i>The availability of check estimates, previous estimates and/or mine production records and whether the Mineral Resource estimate takes appropriate account of such data.</i> • <i>The assumptions made regarding recovery of by-products.</i> • <i>Estimation of deleterious elements or other non-grade variables of economic significance (eg sulphur for acid mine drainage characterisation).</i> • <i>In the case of block model interpolation, the block size in relation to the average sample spacing and the search employed.</i> • <i>Any assumptions behind modelling of selective mining units.</i> • <i>Any assumptions about correlation between variables.</i> • <i>Description of how the geological interpretation was used to control the resource estimates.</i> • <i>Discussion of basis for using or not using grade cutting or capping.</i> • <i>The process of validation, the checking process used, the comparison of model data to drill hole data, and use of reconciliation data if available.</i> 	<p>and the overlying barren rhyolite. This was used to both control interpolation and to assign density to the model (2.57 for granite, 2.70 for greisen and 2.60 for all other material).</p> <ul style="list-style-type: none"> • Analysis of sample lengths indicated that compositing to 1m was necessary. • Search ellipse sizes and orientations for the estimation were based on drill hole spacing, the known orientations of mineralisation and variography. • An “unfolding” search strategy was used which allowed the search ellipse orientation to vary with the locally changing dip and strike. • After statistical analysis, a top cut of 5% was applied to Sn% and W%; a 1.2% top cut is applied to Li%. • Sn% and Li% were then estimated by Ordinary Kriging within the mineralisation solids. • The primary search ellipse was 150m along strike, 150m down dip and 7.5m across the mineralisation. A minimum of 4 composites and a maximum of 8 composites were required. • A second interpolation with search ellipse of 300m x 300m x 12.5m was carried out to inform blocks to be used as the basis for an exploration target. • Block size was 10m (E-W) by 10m (N-S) by 5m • Validation of the final resource has been carried out in a number of ways including section comparison of data versus model, swath plots and production reconciliation. All methods produced satisfactory results.
Moisture	<ul style="list-style-type: none"> • <i>Whether the tonnages are estimated on a dry basis or with natural moisture, and the method of determination of the moisture content.</i> 	<ul style="list-style-type: none"> • Tonnages are estimated on a dry basis using the average bulk density for each geological domain.
Cut-off parameters	<ul style="list-style-type: none"> • <i>The basis of the adopted cut-off grade(s) or quality parameters applied.</i> 	<ul style="list-style-type: none"> • A series of alternative cutoffs was used to report tonnage and grade: Lithium 0.1%, 0.2%, 0.3% and 0.4%. • The final reporting cutoff of 0.1% Li was chosen based on underground mining studies carried out By Bara Consulting in 2017 while developing an initial Probable Ore Reserve Estimate.

Criteria	JORC Code explanation	Commentary
Mining factors or assumptions	<ul style="list-style-type: none"> Assumptions made regarding possible mining methods, minimum mining dimensions and internal (or, if applicable, external) mining dilution. It is always necessary as part of the process of determining reasonable prospects for eventual economic extraction to consider potential mining methods, but the assumptions made regarding mining methods and parameters when estimating Mineral Resources may not always be rigorous. Where this is the case, this should be reported with an explanation of the basis of the mining assumptions made. 	<ul style="list-style-type: none"> Mining is assumed to be by underground methods, with fill. An updated Preliminary Feasibility Study prepared in 2019 established that it was feasible and economic to use large-scale, long-hole open stope mining. The 2022 updated Preliminary Feasibility Study establishes that it is feasible and economic to mine using long hole open stoping with paste backfill. Using a total processing cost of \$41/t and a recovery of 77% of Li grade in ROM ore, a gross payable value per ROM ore tonne of \$96/t (\$55/t net margin) has been assumed before inclusion in the mine plan..
Metallurgical factors or assumptions	<ul style="list-style-type: none"> The basis for assumptions or predictions regarding metallurgical amenability. It is always necessary as part of the process of determining reasonable prospects for eventual economic extraction to consider potential metallurgical methods, but the assumptions regarding metallurgical treatment processes and parameters made when reporting Mineral Resources may not always be rigorous. Where this is the case, this should be reported with an explanation of the basis of the metallurgical assumptions made. 	<ul style="list-style-type: none"> Successful locked-cycle tests (“LCT”) results carried out in 2021 further support the Cinovec project’s credentials to initially produce battery-grade lithium carbonate. <ul style="list-style-type: none"> European Metals has demonstrated that Cinovec battery grade lithium carbonate can be easily converted into lithium hydroxide monohydrate with a commonly utilised liming plant process. Six LCTs were planned but testwork was stopped after four cycles as the main process stream compositions had successfully stabilised. Battery grade lithium carbonate was produced in every LCT with lithium recoveries of up to 92.0% achieved in the four LCTs performed. The LCTs tested zinnwaldite concentrate from the southern part of Cinovec, representative of the first five years of mining. Improved fluoride removal process step further enhances project’s economic outcomes as a result of the regeneration and reuse of the ion exchange resins. Further optimisation work in hydrometallurgy processing steps expected to improve lithium recoveries from concentrate to >92.0%. Extensive testwork was conducted on Cinovec ore in the past. Testing culminated with a pilot plant trial in 1970, where three batches of

For personal use only

For personal use only

Criteria	JORC Code explanation	Commentary
		<p>Cinovec ore were processed, each under slightly different conditions. The best result, with a tin recovery of 76.36%, was obtained from a batch of 97.13t grading 0.32% Sn. A more elaborate flowsheet was also investigated and with flotation produced final Sn and W recoveries of better than 96% and 84%, respectively.</p> <ul style="list-style-type: none"> Historical laboratory testwork also demonstrated that lithium can be extracted from the ore (lithium carbonate was produced from 1958-1966 at Cinovec).
<i>Environmental factors or assumptions</i>	<ul style="list-style-type: none"> <i>Assumptions made regarding possible waste and process residue disposal options. It is always necessary as part of the process of determining reasonable prospects for eventual economic extraction to consider the potential environmental impacts of the mining and processing operation. While at this stage the determination of potential environmental impacts, particularly for a greenfields project, may not always be well advanced, the status of early consideration of these potential environmental impacts should be reported. Where these aspects have not been considered this should be reported with an explanation of the environmental assumptions made.</i> 	<ul style="list-style-type: none"> Cinovec is in an area of historic mining activity spanning the past 600 years. Extensive State exploration was conducted until 1990. The property is located in a sparsely populated area, most of the land belongs to the State. Few problems are anticipated with regards to the acquisition of surface rights for any potential underground mining operation. The envisaged mining method will see much of the waste and tailings used as underground fill.
<i>Bulk density</i>	<ul style="list-style-type: none"> <i>Whether assumed or determined. If assumed, the basis for the assumptions. If determined, the method used, whether wet or dry, the frequency of the measurements, the nature, size and representativeness of the samples.</i> <i>The bulk density for bulk material must have been measured by methods that adequately account for void spaces (vugs, porosity, etc), moisture and differences between rock and alteration zones within the deposit.</i> <i>Discuss assumptions for bulk density estimates used in the evaluation process of the different materials.</i> 	<ul style="list-style-type: none"> Historical bulk density measurements were made in a laboratory. The following densities were applied: <ul style="list-style-type: none"> 2.57 for granite 2.70 for greisen 2.60 for all other material
<i>Classification</i>	<ul style="list-style-type: none"> <i>The basis for the classification of the Mineral Resources into varying</i> 	<ul style="list-style-type: none"> The new 2014 to 2021 drilling has confirmed the Lithium mineralisation

Criteria	JORC Code explanation	Commentary
	<p><i>confidence categories.</i></p> <ul style="list-style-type: none"> • <i>Whether appropriate account has been taken of all relevant factors (ie relative confidence in tonnage/grade estimations, reliability of input data, confidence in continuity of geology and metal values, quality, quantity and distribution of the data).</i> • <i>Whether the result appropriately reflects the Competent Person's view of the deposit.</i> 	<p>model and allowed the Mineral Resource to be classified in the Measured, Indicated and Inferred categories.</p> <ul style="list-style-type: none"> • The detailed classification is based on a combination of drill hole spacing and the output from the kriging interpolation. • Measured material is located in the south of the deposit in the area of new infill drilling carried out between 2014 and 2021. • Material outside the classified area has been used as the basis for an Exploration Target. • The Competent Person (Lynn Widenbar) endorses the final results and classification.
<i>Audits or reviews</i>	<ul style="list-style-type: none"> • <i>The results of any audits or reviews of Mineral Resource estimates.</i> 	<ul style="list-style-type: none"> • Wardell Armstrong International, in their review of Lynn Widenbar's initial resource estimate stated "the Widenbar model appears to have been prepared in a diligent manner and given the data available provides a reasonable estimate of the drillhole assay data at the Cinovec deposit".
<i>Discussion of relative accuracy/ confidence</i>	<ul style="list-style-type: none"> • <i>Where appropriate a statement of the relative accuracy and confidence level in the Mineral Resource estimate using an approach or procedure deemed appropriate by the Competent Person. For example, the application of statistical or geostatistical procedures to quantify the relative accuracy of the resource within stated confidence limits, or, if such an approach is not deemed appropriate, a qualitative discussion of the factors that could affect the relative accuracy and confidence of the estimate.</i> • <i>The statement should specify whether it relates to global or local estimates, and, if local, state the relevant tonnages, which should be relevant to technical and economic evaluation. Documentation should include assumptions made and the procedures used.</i> • <i>These statements of relative accuracy and confidence of the estimate should be compared with production data, where available.</i> 	<ul style="list-style-type: none"> • In 2012, WAI carried out model validation exercises on the initial Widenbar model, which included visual comparison of drilling sample grades and the estimated block model grades, and Swath plots to assess spatial local grade variability. • A visual comparison of Block model grades vs drillhole grades was carried out on a sectional basis for both Sn and Li mineralisation. Visually, grades in the block model correlated well with drillhole grade for both Sn and Li. • Swath plots were generated from the model by averaging composites and blocks in all 3 dimensions using 10m panels. Swath plots were generated for the Sn and Li estimated grades in the block model, these should exhibit a close relationship to the composite data upon which the estimation is based. As the original drillhole composites were not available to WAI. 1m composite samples based on 0.1% cut-offs for both Sn and Li assays were • Overall Swath plots illustrate a good correlation between the composites and the block grades. As is visible in the Swath plots, there has been a large amount of smoothing of the

Criteria	JORC Code explanation	Commentary
		block model grades when compared to the composite grades, this is typical of the estimation method.

For personal use only