



AIRA
AUSTRALASIAN
INVESTOR RELATIONS
ASSOCIATION

AUSTRALASIAN INVESTOR RELATIONS ASSOCIATION
ABN 66095554153
GPO Box 1365, Sydney NSW 2001 |
t +61 2 9872 9100 e administration@australasianir.com.au w australasianir.com.au

14 April 2022

Ms K Webb
Senior Manager, Issuer Services
ASX Limited
20 Bridge Street
Sydney NSW 2000
Issuers@asx.com.au

Dear Ms Webb

Re: Stakeholder feedback on proposed changes to Issuer Services fees for ASX-listed companies

I write in response to the proposed changes to ASX Issuer Services fees for ASX-listed companies in my capacity as CEO of the Australasian Investor Relations Association (AIRA).

The Association's 160 corporate members are principally ASX 300 listed entities who collectively represent over A\$1.2 trillion of the total market capitalisation of entities listed on ASX. Having reviewed and considered the proposed changes to fees for Issuer services (the 'New Model') detailed in the 'Issuer Services: New Pricing Discussion Paper' (the 'Paper') released by ASX on 3 March 2022 and as further explained during the AIRA member briefing provided by yourself and Andrew Jones of ASX on 23 March 2022, we provide detailed feedback below and summarise here as follows:

- 1. Objectives vs Implementation.** We agree that the current Issuer services fee structure ('Current Model') has become unworkably complex, leaving most Issuers unable to forecast their likely liabilities, nor reconcile their actual expenses with services received. In analysing the Paper and additional information provided we identify 7 objectives guiding ASX in its design of the New Model, each of which we commend ASX for pursuing. At this time however, given apparent conflicts among some of the objectives and the absence of practical experience with the New Model, AIRA cannot be confident that the objectives detailed will be met if the New Model were to be implemented as drafted.
- 2. Elimination of CHES Statement fee for Issuers.** While the Paper details a proposed reduction in the cost of paper statements sent to holders from \$1.25 to \$0.50 per statement and unlimited electronic statements at 'no additional charge' (the cost of preparing and sending electronic statements to be covered in the new 'base subscription price'), this does not address the fundamental flaw in the Current Model with respect to CHES Statements fees i.e. that they should not be levied on Issuers at all. The issuance of CHES holding statements is a protocol designed to protect Investors from the error, misadventure or deliberate misdeeds of Stockbrokers (sponsoring participants) and as such, it is those parties that should fund the cost of the process.

3. HIN averaging & 'Reconcile and Reset' proposal. Despite the obvious efforts of the ASX to create a simpler fee model that provides Issuers with greater certainty around the fees they pay, we believe the ability for most Issuers to confidently predict the impact of the New Model on their future fees is limited. This being the case and in order to ensure the objectives of the ASX are met to the fullest extent possible, we propose:

- a) **HIN averaging.** Rather than calculating the monthly Subscription Fee based on the number of holders ASX managed on HIN for each Issuer at the end of the previous month, that a 12-month rolling average of this number be used for the Subscription Fee calculation in order to smooth out the volatility that will otherwise occur, thereby allowing for significantly improved forecastability of this charge; and
- b) **Reconcile and Reset.** Given the absence of any practical experience with the New Model to draw upon, we propose a twelve- month introductory period (the 'Introductory Period'), followed by a review of the Issuer Services fees levied on each Issuer at the end of the 2022-23 financial year. The review would focus on ensuring Issuers experience a 10-15% lower fee and if not, a rebate would be paid by ASX. It would also ensure that all other objectives were met and if not, appropriate adjustments made to the New Model to ensure they are addressed post the Introductory Period.

As explained above, we now provide further detail with respect to the three items raised.

1. Objectives vs Implementation

AIRA agrees that the current range of fees charged by ASX for Issuer services and the basis upon which they are calculated, has become unworkably complex and impossible for most Issuers to forecast or reconcile. We commend ASX for recognising these issues and seeking to move to a simpler fee model that provides *"...greater certainty to issuers about ASX charges for Issuer services"*¹

We further note the ambition of the ASX to ensure that:





*"...the fees should better reflect the services provided by ASX Issuer Services and scale appropriately to factors within the control of issuers."*²

¹ 'Issuer Services: New Pricing. Discussion Paper', ASX, 3 March 2022, P 3

² Ibid



From our analysis of the Paper and the commentary provided during the AIRA member briefing given by yourself and Andrew Jones of ASX on 23 March 2022, We identify 7 objectives guiding ASX in its design of the New Model. AIRA is highly supportive of each of the objectives and believes their successful implementation should lead to a significantly improved fee structure for ASX-listed Issuers. At this time however, given apparent conflicts among some of the objectives and the absence of practical experience with the New Model, AIRA cannot be confident that all the objectives of the proposed Fee model will be met.

Our specific comments and concerns with respect to the achievement of each objective are as follows:

	Objective		AIRA comment/concern
1.	Simplicity		We agree that the New Model is "...substantially simpler..." ³ than the Current Model.
2.	Forecastability (greater certainty)		While it is likely there would be some improvement in this area were the New Model to be implemented as proposed, we believe it is important to pursue improvement in all areas and that additional opportunities exist to improve the forecastability of Issuer services fees.
3.	Transparency (ability to be reconciled)		We support the move to greater transparency and believe the ability for Issuers to be able to easily reconcile fees levied with services received is vital to ensuring confidence in the New Model. At this time, and without any practical experience with the New Model however, we cannot be confident that this objective will be achieved.
4.	Scale with service provided		We support the 'user pays' logic of this objective.
5.	Allows Issuers to budget based on known variables		Given the major variable in the calculation of the monthly Subscription Fee is the "...number of holders ASX manages on HIN for each Issuer, determined as a snapshot at the end of the previous month..." ⁴ , and that this number will

³ Ibid

⁴ Ibid, P 13

			change - sometimes dramatically ⁵ - each month for most Issuers, from a practical perspective, we are of the view it cannot be regarded as a known variable.
6.	Scales appropriately to factors within the control of Issuers		Given Issuers cannot control the entry or exit of shareholders from their register, we do not see how this objective is achieved under the structure currently proposed.
7.	10-15% lower for most Issuers		While We support the reduction of fees for Issuers, without the practical experience of working with the New Model, we have limited confidence that the identified reduction will be achieved (particularly as there has been no commitment made with respect to Listing Fees).

2. Elimination of CHESSE Statement fee for Issuers

While the New Model proposes a significant reduction in the cost of CHESSE statements, this does not address the fundamental flaw of the Current Model i.e. that CHESSE Statement fees are levied on the incorrect party.

According to ASX, the provision of CHESSE holding statements to holders is:

*"...an important **investor** protection measure to identify potential fraud or error. It provides an independent notification of changes to holdings or related information **of an investor**, an important validation function."*⁶

It goes on to say:

*"Transactions on a CHESSE holding can only be effected by the **sponsoring participant**. By law a **sponsoring participant** may only effect transfers from a CHESSE holding when authorised by the **registered holder (investor)** to do so."*⁷

⁵ During the Pandemic, Computershare noted a 20% increase in the number of retail shareholders across its 800+ client base, however this number masked the experience of some companies which saw retail shareholders grow by more than 100% during the period and included one company which witnessed growth of more than 400% (Source: Computershare).

⁶ [Business Committee Meeting Agenda Item 2B](#), ASX, 19 September 2019, P 13

⁷ Ibid

Finally:

*“...Your **CHES**S Sponsor must authenticate **your identity** when **you** give them instructions...”⁸*

It is clear from the ASX’s own explanations of the system, that the issuance of CHES holding statements is a protocol designed to protect investors from the error, misadventure or deliberate misdeeds of stockbrokers (sponsoring participants). We further demonstrate this point in the diagram below detailing the most common chain of events involving the issuance of a CHES statement:

Retail Investor share transaction - activity flow

1. Investor places order with Broker
2. Broker executes order via ASX
3. Broker sends contract note to Investor
4. Broker settles trade with ASX Settlement
5. ASX Settlement sends CHES statement to Investor

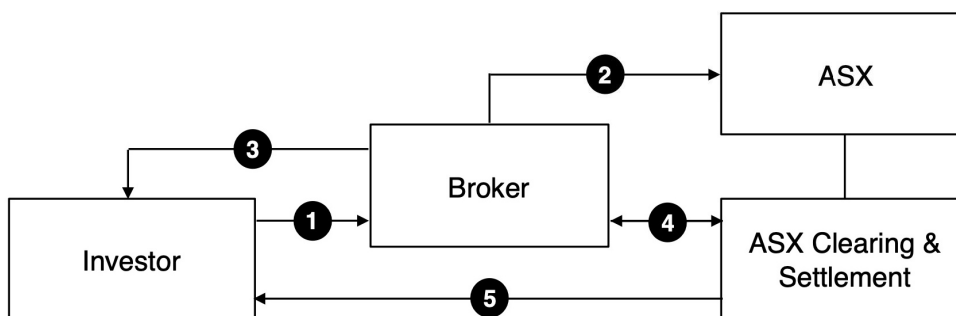

As is further evidenced here, the Issuer plays no role in the process that results in the issuance of the CHES statement, nor is it the primary, or even secondary beneficiary of this process.

For reasons unknown, Issuers have been footing the bill for the CHES statement process since the introduction of CHES in 1994. While it is unfortunate, we cannot rewrite this unjust history, it is imperative any new fee structure instigated by ASX for its revised CHES statement process ensures the charges for it are levied on the correct basis and to the correct party or parties i.e. Stockbrokers and/or Investors.

AIRA is aware that the change detailed above will necessitate a change to ASX Business Rules and as such, it may not be possible to make the required changes by the proposed 1 July 2022 start date for the New Model. This being the case, we understand that Issuers may need to be charged for CHES statements for some part of the Transition Period, however this should cease as soon as possible, and in any event, no later than the conclusion of the Transition Period i.e. 30 June 2023.

⁸ https://www.asx.com.au/documents/research/chess_brochure.pdf

3. HIN averaging & 'Reconcile and Reset' proposal

Despite the obvious efforts of the ASX to create a simpler fee model that provides Issuers with greater certainty around the fees they pay, we believe the ability for most Issuers to confidently predict the impact of the New Model on their future fees is limited.

We believe two modifications to the New Model as currently drafted, would enhance the model and deliver a significantly greater likelihood of achieving the objectives as outlined. The first of these we refer to as 'HIN averaging'.

a) HIN averaging

The current proposal for calculating the monthly Subscription Fee is based on the number of holders ASX managed on HIN for the Issuer at the end of the previous month. Given this number may change for the Issuer on a daily basis, it is likely that for many Issuers, there will be significant volatility on a monthly basis, such volatility directly impacting the ability of the Issuer to accurately forecast its liabilities to the ASX.

While we support the 'user-pays' principle of the New Model, we believe a modification to the formula - replacing the 'snapshot at the end of the previous month'⁹, with a 12-month rolling average of this number (the 'AIRA Model') - will reduce the volatility that will otherwise occur and consequently allow for improved forecastability and reduced volatility of this charge, as demonstrated below:

⁹ 'ASX, 3 March 2022, Op Cit, P 13

AIRA Submission

Stakeholder feedback on proposed changes to Issuer Services fees for ASX-listed companies

Month		New Model		AIRA Model		
		Holders on HIN	% Change	Holders on HIN	12-Mth Avg	% Change
1	July 2021	20,000		20,000		
2	August 2021	22,500	12.50%	22,500		
3	September 2021	25,000	11.11%	25,000		
4	October 2021	21,300	-14.80%	21,300		
5	November 2021	24,300	14.08%	24,300		
6	December 2021	26,238	7.98%	26,238		
7	January 2022	27,800	5.95%	27,800		
8	February 2022	25,300	-8.99%	25,300		
9	March 2022	22,354	-11.64%	22,354		
10	April 2022	24,923	11.49%	24,923		
11	May 2022	26,720	7.21%	26,720		
12	June 2022	29,334	9.78%	29,334	24,647	
13	July 2022	26,302	-10.34%	26,302	25,173	2.13%
14	August 2022	23,245	-11.62%	23,245	25,235	0.25%
15	September 2022	21,000	-9.66%	21,000	24,901	-1.32%
16	October 2022	24,321	15.81%	24,321	25,153	1.01%
17	November 2022	23,290	-4.24%	23,290	25,069	-0.33%
18	December 2022	26,340	13.10%	26,340	25,077	0.03%

Issuer Services fees variability example - New Model vs AIRA Model



b) Reconcile and Reset

Secondly, given the absence of any practical experience with the New Model to draw upon, we believe a 12 month introductory period (the 'Introductory Period'), followed by a review of the Issuer Services fees levied on each Issuer at the end of the 2022-23 financial year, is a pragmatic approach to ensuring the 'law of unintended consequences' does not leave either the ASX or Issuers, encumbered with a system that did not work as all parties intended at the outset.

The review would include ensuring that Issuers experienced a 10-15% lower fee as anticipated and if not, a rebate would be paid by ASX. It would also ensure all other objectives were met and if not, appropriate adjustments made to the New Model to ensure they were met post the Introductory Period.

Additional comments and conclusion

In addition to the commentary above pertaining to the specifics of the New Model, we would like to take this opportunity to make the following general points:

- a) **Rising cost of being a listed entity.** Our members are increasingly conscious of the rising cost of being a listed entity driven not only by rising ASX fees, but also amongst other things, the costs of complying with ASX listing rules and the Corporations Act in an ever more litigious world.

- b) **Move to digital shareholder communications.** While we commend the ASX for its recent launch of CHESSE e-statement functionality, we are conscious that the availability of the functionality alone will not solve the problems of paper-based communication if broad adoption is not achieved. We urge ASX to do everything within its power – including the permanent elimination of the charge to Stockbrokers for passing email addresses through to CHESSE - to encourage the immediate and permanent adoption of the new functionality. Not only will this eliminate the enormous wastage and environmental damage associated with paper-based CHESSE statements, but also facilitate the continued transition to full digital communications from Issuers to shareholders by passing more email addresses through to the share registries. In order to further progress this matter, we also request urgent attention to the changing of ASX Business Rules associated with the hard copy confirmation of change of address details – whether that be with respect to CHESSE records or those held by the share registries. Given the all-pervasive nature of digital communication in Australia and elsewhere in recent years, this is a further example of an outdated rule that must be replaced to reflect today's technologies and societal expectations.

Finally, once again we commend the ASX for seeking to move to a simpler, fairer fee model for Issuer services. We look forward to working with you to optimise the final structure and are available to discuss the above at your earliest convenience.

Yours sincerely



Ian Matheson
Chief Executive Officer